

THE MEASUREMENT SOLUTION.

**burster**



# Load cells

**FOR PRODUCTION, AUTOMATION, R&D  
AND QUALITY ASSURANCE**

[www.burster.com](http://www.burster.com)

# A powerful force taking measurements forward

**SMART LOAD CELLS KEEPING PACE WITH ADVANCES IN PROCESS CONTROL.**

## PRODUCTS DESIGNED FOR THE CHALLENGES OF OUR AGE

Our customers operate in practically every branch of industry around the world and expect products to work perfectly 100% of the time. As the requirements set by exacting production processes and quality assurance standards become ever more stringent, process control depends increasingly on sensors and analysis equipment.

**As one of the leading manufacturers of load cells,** we can provide innovative ideas, experience-led advice and smart solutions for all production and quality assurance processes. Our customers value our extensive applications experience and our high-quality, practical solutions to the demands of the market.



## VARIABLE CHALLENGES NEED VERSATILE SOLUTIONS

In addition to innovative and trusted standard products, from miniature to large-scale, here in the high-powered, high-tech Karlsruhe region of Germany we also develop and manufacture tailor-made OEM sensor solutions for very specific measurement tasks and specialized applications.

It is essential to look at the process chain in depth to find the right load cell for the job and the environment. Along with the ideal load cell, a measurement system requires mechanical parts plus instrumentation for measurement data acquisition, analysis and reporting.

burster offers high-quality load calibration equipment plus extensive testing and calibration experience to guarantee the traceability and optimum reliability you need. Analysis software and a comprehensive suite of customer services complete the burster package of solutions.

## RELIABILITY AT YOUR FINGERTIPS – burster PLUG & PLAY

Smart interaction is the key to success in a world where sharing information is ever more important. Interconnecting people, machinery and products in fully or semi-automated production processes is a challenging and demanding reality. Engineers must design processes to be easy to monitor, quantify, reproduce and analyze while aiming for ever greater reliability.

Sensor-specific data is stored in the sensor connector using innovative burster TEDS technology. The analysis instrument reads this sensor data and uses it for the automatic configuration of the evaluation electronics. This not only protects against setting incorrect parameters but makes it easier to change sensors while saving time and money spent on configuration.

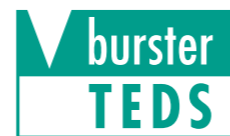

# Strength in practice

**burster LOAD CELLS FIT YOUR NEEDS PRECISELY.**

## FROM THE SPECIFIC TO THE UNIVERSAL – GLOBAL SOLUTIONS

Force measurement is increasingly relevant to growth markets such as the automotive engineering, electro-mobility, drive technology and machine manufacturers. burster has decades of experience in designing, building and using standard and custom OEM load cells and in providing valuable applications advice in many different industrial and research sectors, making burster expert in solving the optimum force measurement solution. **Take advantage of our experience now to gain that competitive edge.**

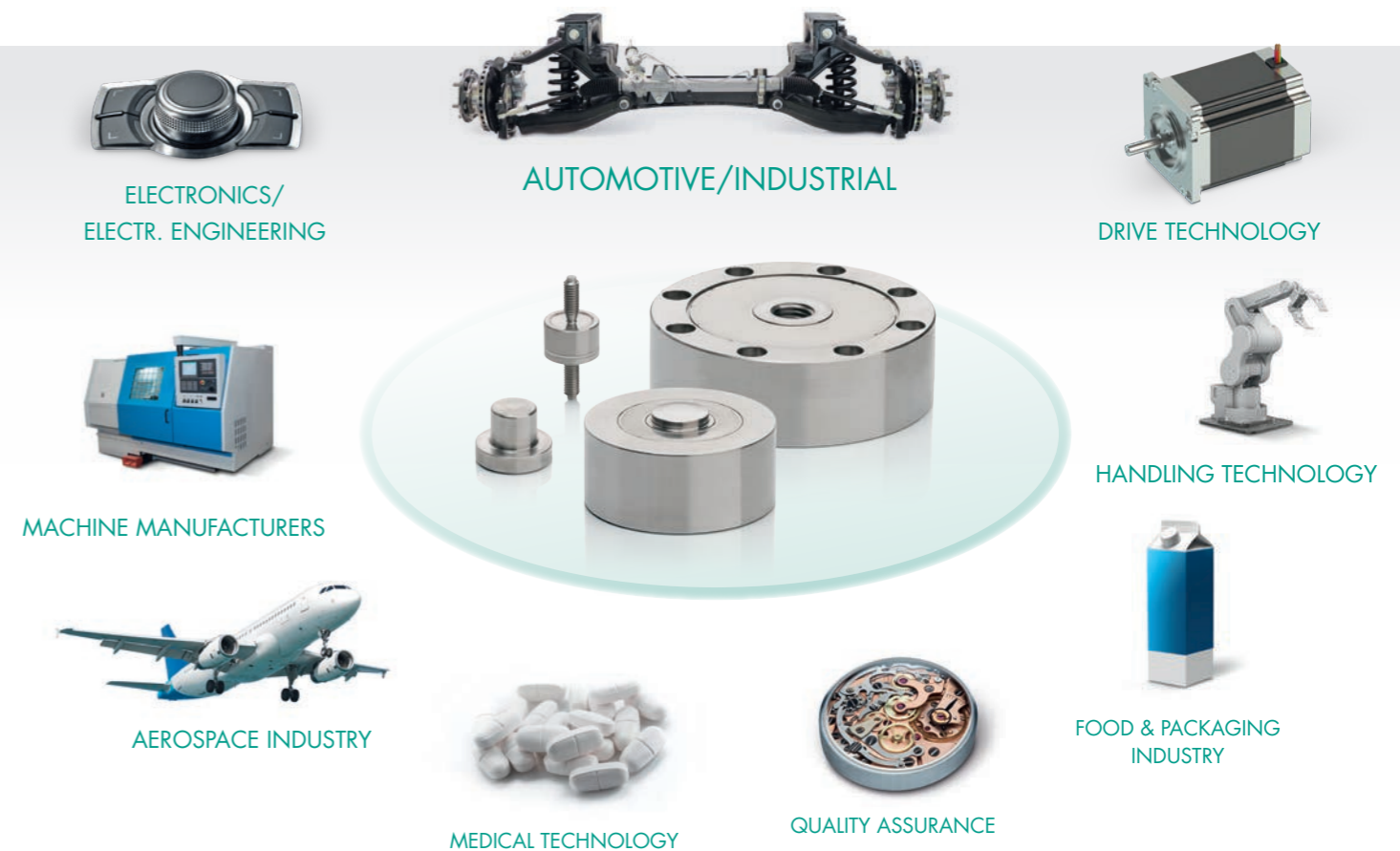

## SPARTAN OR SOPHISTICATED – EXPERTLY DESIGNED STANDARD AND CUSTOM OEM PRODUCTS

As a load-cell manufacturer with decades of design and production experience gained within the same company, burster is able to offer economically viable custom OEM solutions even for highly specialized applications, modified standard sensors or strain gage attachment to original customer parts. Our skills portfolio ranges from solving simple force measurement tasks to designing complex force monitoring systems.

For instance outstanding, future-proof measurement solutions can be achieved by combining a load cell with the DIGIFORCE® process controller range or the new fieldbus-compatible 9250/9251 instrumentation amp technology. This lets you log and visualize your processes reliably while transferring the OK/NOK analysis results to your control environment via the latest Ethernet-based fieldbuses. In other words Industry 4.0 right here, right now.

**Standard product, custom solution or an exclusive OEM product?  
Low-cost or high-end? Which route do you want to take with us?**





# Force measurement done properly

**burster – PERFECTLY SKILLED IN THE ART OF LOAD CELL DESIGN.**

## LOAD CELLS – THE WAY TO MEASURE THE MECHANICAL VECTOR QUANTITY OF FORCE (F)

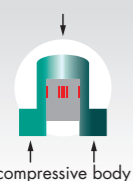
Load cells consist of a spring element, which experiences elastic and linear deformation as a result of the force being measured, and a device for measuring this deformation. There are various ways of measuring small deformations. The aim is always to map the mechanical parameter “deformation” onto the electrical parameter “voltage”.

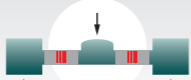
### Diversity – The different sensor elements and their most common designs. How to make the right choice for your application.

				
<ul style="list-style-type: none"> <li>Smallest possible design</li> <li>Less sensitive to impact loads</li> <li>Covers large measuring ranges</li> </ul>	<ul style="list-style-type: none"> <li>High precision</li> <li>Large nominal displacement</li> <li>Good-value external overload protection</li> </ul>	<ul style="list-style-type: none"> <li>Low-cost design</li> <li>Low overall height</li> <li>Small diameter possible</li> </ul>	<ul style="list-style-type: none"> <li>Frequent load cycles</li> <li>Insensitive to lateral forces</li> <li>Suitable for dynamic loads</li> </ul>	<ul style="list-style-type: none"> <li>High rigidity</li> <li>Withstands external forces</li> <li>Suitable for impact loads</li> </ul>

### SPRING ELEMENT – the central component

The purpose of the spring element is to absorb the force to be measured and convert it into a uniform strain range. The elastic properties of the spring materials are used to measure the force indirectly. Strain gages measure the strain on the surface of the spring element. Strain gages are made of a metal foil rolled onto a substrate. A meandering resistive pattern is etched from this metal foil.

### STRAIN GAGES – transform force into signal

Complicated processes are used to apply strain gages to the surface of the spring element. At burster this is obviously done with the greatest precision and maximum quality, to ensure they are subject to the same deformation as the spring element. When the strain gages are deformed, they change their length and conductor cross-section. The effect of both is to increase the electrical resistance. This expansion or compression, and hence the force, is measured electrically as a change in resistance.

### LOAD CELLS – accurate in every situation

Load cells have to cope with a huge range of mechanical conditions. For instance they may have to fit into tight spaces, deliver exceptionally fast readings, withstand lateral forces, deal with impact loads or track frequent load changes. This is why differently shaped measuring elements are used in the sensors, each possessing specific advantages for their area of use.

### PRECISION – everything in its place

The design of every measuring element is concerned with providing on the sensor a suitable location on which the strain gages can be applied. This location must provide enough space to accommodate the strain gages so that they produce a strain as specified and exhibit absolutely linear and reproducible behaviour.

# Your guide to precision force measurement

**SENSORS AND SERVICE FOR EVERY APPLICATION.**

## CONTENTS

<b>Measuring force</b> in the industrial environment	2
<b>Applications</b> of force measurement using standard and OEM solutions	3
<b>Useful background knowledge</b> on force measurement and sensor designs	4

## SENSORS/APPLICATIONS

### COMPRESSION LOAD CELLS

<b>8402</b>	Miniature	6
<b>8413/8414</b>	Subminiature	8
<b>8526</b>	Compact	10
<b>8415/8416</b>	Miniature	12
<b>8438</b>	Miniature	12
<b>8532</b>	Low-cost	14
<b>85043/85073</b>	Precision	14
<b>8527</b>	High-precision	16
<b>8451/8552</b>	Load cells for presses	16

### TENSION & COMPRESSION LOAD CELLS

<b>8524</b>	Precision – internal thread	18
<b>8435</b>	Miniature – internal thread	20
<b>8523</b>	Standard – internal thread	22
<b>85041/85075</b>	Precision – internal thread	22
<b>8431/8432</b>	Miniature – external thread	24
<b>8417</b>	Miniature – external thread	26
<b>8427</b>	Compact – external thread	26

### BENDING BEAMS

<b>8510/8511</b>		28
<b>8512</b>	S-beam	28

### MULTIDIMENSIONAL LOAD CELLS

<b>8560</b>	Multidimensional	30
<b>85SD-M231</b>	Multi-axis	30







### SPECIAL SENSORS







<b>85SD-F502</b>		32
<b>85SD-F312</b>		32
<b>8400-B001</b>		33
<b>8500-B004</b>		33

<b>Special-design OEM load cells &amp; contract manufacturing strain gage mounting</b> Tailor-made and economic solutions for small-scale to large-scale production	34-35
<b>Comparison chart – sensors in product groups 8.4 and 8.5</b>	36-37
<b>Sensor-signal analysis</b> – the correct interface for every application	38
<b>Sensor electronics</b> – instrumentation amplifiers and sensor interfaces	39
<b>Sensor electronics</b> – digital indicators and calibrators	40
<b>Sensor electronics</b> – process monitoring using process controllers	41
<b>Accessories, calibrated alignment with instrumentation, cable/connector assembly</b>	42
<b>Service and after-sales services</b> – the burster all-inclusive package for peace of mind	43
<b>Calibration</b> – every aspect of calibration, in-house and on-site, DAkkS calibration laboratory D-K-15141-01-00	44-45
<b>Glossary/FAQ</b>	46-47

# Comparison chart

ALL LOAD CELL RANGES AT A GLANCE.







MODELS	8402	8413	8414	8415	8416	8417
Figure						
Page	6 - 7	8 - 9		12 - 13	12 - 13	26 - 27
Description	Miniature compression load cell	Subminiature compression load cells with overload protection		Miniature compression load cell	Ultra-miniature compression load cell	Miniature tension and compression load cell
Non-linearity	0.5	0.25	0.25	0.5/0.75	0.5	0.5
Measuring Range smallest: largest:	0 ... 1 kN 0 ... 100 kN	0 ... 5 N 0 ... 5 kN	0 ... 5 N 0 ... 100 N	0 ... 200 N 0 ... 5 kN	0 ... 20 N 0 ... 5 kN	0 ... 10 N 0 ... 5 kN
Special Features	Large measuring ranges combined with small dimensions, short measurement deflection, high number of load cycles	Ultra-small external dimensions, extremely low overall height with temperature compensation, high resonance frequency (up to 167 kHz)	Overload protection included in ultra-small external dimensions	Economical flat disc sensor, external diameter 20 mm	Extra-small load cell, external diameter 10.6 mm and height 4.5 mm	Just 10 mm in diameter and 6.5 mm in height, easy to fit using external thread
Main Application Fields	Measurement of press-insertion forces on longitudinal and lateral press-fit seatings, measurement of force in punching machines, chucks and tools	Where space is tight for measuring contact and friction forces and testing pushbuttons & switches	Automatic production lines, for testing joints and smooth running	Contact forces, positioning forces, pressing forces in machines	Instrument-making, microsystem technology, production lines, handling equipment	Micro-mechanics, actuator systems, switches, bowden cables





MODELS	8510	8511	8512	8523	8524	8526
Figure						
Page	28 - 29	28 - 29	28 - 29	22 - 23	18 - 19	10 - 11
Description	Miniature bending beam load cell	Bending beam load cell	S-beam tension and compression load cell	Tension and compression load cell	Precision tension and compression load cell	Compression load cell
Non-linearity	0.25	0.1	0.1	0.15	0.1	0.25
Measuring Range smallest: largest:	0 ... 1 N 0 ... 20 N	0 ... 5 N 0 ... 2 kN	0 ... 20 N 0 ... 880 N	0 ... 20 N 0 ... 5000 N	0 ... 500 N 0 ... 200 kN	0 ... 100 N 0 ... 200 kN
Special Features	Mechanical overload protection, very small size	Insensitive to sources of parasitic errors and lateral forces	High number of load cycles > 10 <sup>6</sup> , connecting cable suitable for drag chains	Economical multipurpose aluminium sensor, lightweight, compact	Robust load cell for industrial and laboratory applications, available with overload protection	Compact design combined with high measuring ranges, protection class IP64, internal thread for easy fixing
Main Application Fields	Test equipment (switches, pushbuttons), contact forces, packaging and adhesive technology	Weighing equipment, filling scales, water level gages, filling equipment	Automated tool testing, test and analysis systems in the pharma industry, measuring loads in cable systems	Forces in rods, bars and frameworks, counting and test scales	Monitoring jointing processes, torque measurement via force x lever length	Contact forces, pedal forces, filling systems, presses

- Options:**
- Extended temperature range from -55 °C ... +200 °C
  - Hermetically sealed version (IP68) / submersible cable
  - Standardization of nominal sensitivity

- Built-in amplifier
- Integrated cable, including range of lengths for drag chain use
- Vacuum equalization hole

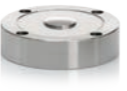
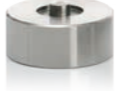
- Load application parts
- Pull plates

8427	8431	8432	8435	8438	8451/8552
					
26 - 27	24 - 25		20 - 21	12 - 13	16 - 17
Tension and compression load cell	Miniature tension and compression load cells		Tension and compression load cell	Miniature ring load cell	Presses load cells
0.7	0.15	0.15	0.25	1.0	0.5
0 ... 100 N 0 ... 10 kN	0 ... 10 N 0 ... 100 kN	0 ... 5 N 0 ... 2 kN	0 ... 200 N 0 ... 5 kN	0 ... 5 N 0 ... 200 kN	0 ... 100 N 0 ... 100 kN
Each end fitted with a flange designed for holding with a spanner, also available with external thread, choice of fixing options	Versatile precision sensor, insensitive within limits to lateral forces, bending and torsion moments, IP68, temperature from -55 °C ... +200 °C	Like model 8431, but with overload protection for both tensile and compressive loads	Stainless steel tension and compression load cell for OEM applications	Central through-hole, low overall height	Easy to fit directly, factor of 10 mechanical overload protection, attachment for mounting displacement sensor actuator
All areas of mechanical engineering, automated production, test equipment for safety areas on rail vehicles	Push and pull rods, balancing scales, electromagnets, baffles	Production and test lines, but also laboratory equipment	Press-insertions, forming operations, proportioning, connector tests	Measurement of screw-connection force, contact forces of bolts, threaded rods, cutting forces	Manual presses and automatic pressing stations

8527	8532	8560	85041/85043 85073/85075	855D-M231
				
16 - 17	14 - 15	30 - 31	22 - 23 / 14 - 15	30 - 31
High-precision compression load cell	Low-cost compression load cell	Multi-axis tension and compression load cells	Precision tension and compression load cells	Multi-axis load cell
0.05	1	0.5	0.1	0.1
0 ... 500 N 0 ... 100 kN	0 ... 500 N 0 ... 20 kN	0 ... 250 N 0 ... 50 kN	0 ... 20 N 0 ... 2 MN	X: 0 ... 2000 lbs Y: 0 ... 1000 lbs
High-precision sensor, protection class IP65, easy to fit	Particularly economical load cell with IN-LINE amplifier, output 0 ... 10 VDC	Compensated temperature range -40 ... +120 °C, can be customized, extremely high factor for the nominal force ratio Fz/Fx, CANopen	Precision sensors, hermetically sealed, very low sensitivity to lateral forces, also suitable for highly dynamic applications	Up to 100 million load cycles, low cross-talk < 0.5 % F.S., standardized nominal sensitivity
As a reference in precision measurements in both laboratory and industry	Weights, press-insertions, feed forces	Medical technology, automated handling and robotics, sorting systems, multi-axis use in R&D	Presses, containers (e.g. silos), materials testing, calibration	Testing and balancing car and truck tyres

- Services:**
- In-line calibration with external instrumentation
  - Cable/connector assemblies
  - DAkKS/factory calibration certificate

- Custom full scale calibrations
- User training and commissioning training
- Online retrieval of calibration and test certificates

You can find further information on our load cells at [www.burster.com](http://www.burster.com). Our website contains detailed technical **data sheets**, **installation instructions** and **CAD data** available for download.

You can also use the website comparison tool to compare directly the sensors you are specifically interested in, and contact us **online with your questions**.

Visit us at our website or call us! We are happy to help.

- CAD data
- How-to-do videos
- Application advice

# Sensor instrumentation for every application

MEANINGFUL ANALYSIS OF YOUR SENSOR SIGNALS.

## WITHOUT ANALYSIS, SENSOR SIGNALS REMAIN DATA STREAMS WITHOUT VALUE

Without the correct signal amplification, post-processing, visualization, analysis and evaluation in the context of your requirements, sensor signals simply remain useless streams of data. **The success of your process monitoring set-up ultimately depends on these signal processing steps.**

Depending on the application and degree of automation, you are faced with issues of networking, speed, accuracy, interfacing, integration and economic viability. **High performance and optimum utilization** of your processes are essential if they are to meet future requirements reliably and flexibly.



## THE CORRECT INTERFACE FOR YOUR APPLICATION

burster offers you the **full spectrum of sensor signal acquisition and analysis tools, from simple digital indicator to high-end process controller.** We use our decades of experience to give you precisely the advice you need.

Take advantage of our applications advice at the start of a project, or our optimization suggestions for on-going processes. If decision is made for sensor and relevant electronics, we will of course be happy to align the sensor with electronics and supply you with the full measurement chain. DAkKS and factory calibration certificate available on request.

Using high-quality sensors and appropriate instrumentation from burster your business benefits from quality, flexibility and efficiency and the confidence to operate in fast-changing markets. The burster comprehensive package gives you peace of mind, because you can rely on precise, rapid measurement data acquisition.

## RELIABILITY AT YOUR FINGERTIPS – burster PLUG & PLAY



Smart interaction is the key to success in a world where sharing information is ever more important. Interconnecting people, machinery and products in fully or semi-automated production processes is a challenging and demanding reality. Engineers must design processes to be easy to monitor, quantify, reproduce and analyze while aiming for ever greater reliability.

Sensor-specific data is stored in the sensor connector using innovative burster TEDS technology. The analysis instrument reads this sensor data and uses it for the automatic configuration of the evaluation electronics. This not only protects against setting incorrect parameters but makes it easier to change sensors while saving time and money spent on configuration.

## INSTRUMENTATION AMPLIFIERS AND SENSOR INTERFACES

burster amplifier products are used wherever sensor signals from strain gage, potentiometric or DC/DC sensors need to be converted into standard voltage or current signals and supplied to a PLC or other host systems for further analysis. These products will be indispensable in **future production environments** where, in addition to their traditional role of amplifying and transferring sensor signals, they will need to perform this task in the context of **Industry 4.0** using **flexible fieldbus connections via modern interfaces** such as i.e. PROFINET. burster also offers a high-performance Plug&Measure solution for PC-based measurement tasks.

## THE NEW INSTRUMENTATION AMPLIFIER GENERATION 9250/9251

- Ready to use with any make of sensor for your measurement needs, manufacturer independent
- Ultra-fast pushbutton configuration
- Automatic sensor recognition due to burster TEDS
- Suitable for force, pressure, displacement, rotational speed and torque measurements, including combined measurements
- Synchronous export of up to 8 measurement channels via the bus controller
- Supports Ethernet-based fieldbuses as PROFINET, EtherCAT, EtherNet/IP or I/O interface
- Tare facility via pushbutton or I/O signals for each 9250 amplifier
- Up to two real-time signals/limit switches per amplifier module
- Versatile configuration using DigiVision PC software via USB port

NEW

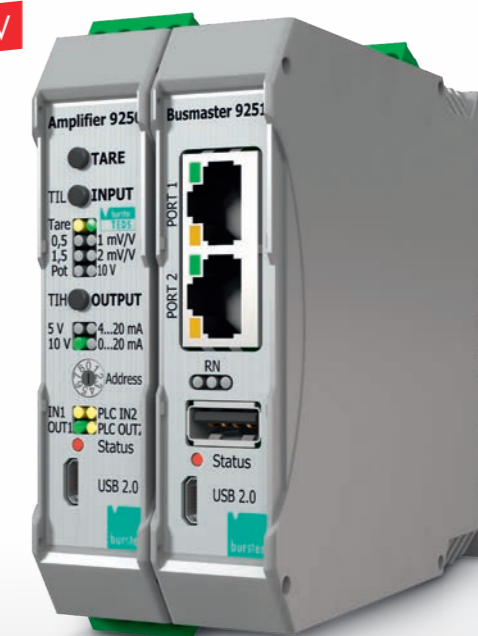

## Sensor interfaces 9206 and 9236 with Plug&Measure concept.



### 9206 USB multi sensor interface for strain gage sensors

- Plug&Measure version or four-channel version
- Simple connection via PC USB port
- 24-bit resolution
- High-speed measurement of up to 1200 readings/s
- Measurement accuracy of at least 0.01 %
- LabVIEW and DLL drivers available free of charge

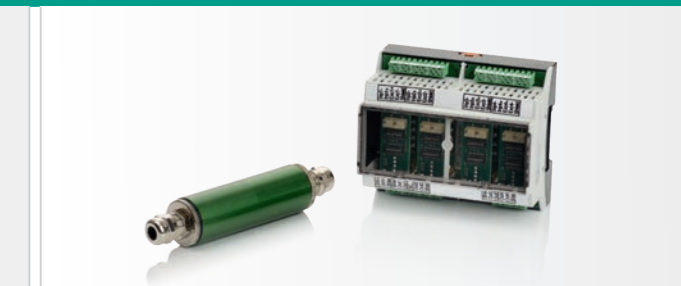

### 9236 multichannel amplifier for strain gage sensors

- Tubular housing, DIN-rail mounting or PCB version
- Voltage output 0 ... ±5 V / 0 ... ±10 V
- Protected against reverse connection and short-circuit
- Also available as circuit board without housing
- Multi-channel capability
- High protection class up to IP67

# Sensor instrumentation for every application

## MEANINGFUL ANALYSIS OF YOUR SENSOR SIGNALS.

### DIGITAL INDICATORS AND CALIBRATORS

**Digital indicators receive the measurement signals from your load cells and convert them for presenting on a display.** Depending on their range of functions, these instruments already help you to analyze your measurement signals and can transfer the evaluated measurement data to the higher-level control environment. Limit-setting and visual alarms on the display are convenient features for handling sensor signals. Portable indicators and calibrators provide a straightforward means for you to perform your self-governed device testing and calibration directly in your production environment without lengthy production downtimes.

The **9163 digital indicator** covers a wide range of applications in which process values need to be measured, displayed, analyzed and transferred to higher-level control systems.



#### SENSORMASTER 9163

- For force, pressure or torque measurements using strain gage sensors
- For distance or angle measurements with potentiometric or DC/DC sensors
- Measurement accuracy of 0.1 % and sensor-specific linearization
- Range of mathematical functions (e.g. differential measurement)
- OK/NOK feedback on multicolour display and via 4 alarm limit outputs
- High sampling rate (500/s)

The multipurpose **7281 TRANS CAL testing device** can be used wherever there is a need to perform high-precision, on-site calibrations of sensing components used in equipment such as presses, torque tools or pressure-regulating systems.



#### TRANS CAL 7281 mobile high-precision calibrator and testing device for mechanical and electrical measurements

- Compatible sensors: Strain gage/standard signal  $\pm 5$  V,  $\pm 10$  V, potentiometric sensors
- Device test: strain gage simulator up to  $\pm 50$  mV/V
- Easy configuration via burster TEDS
- Excellent linearity with an error of just  $\pm 0.001$  %
- Storage of up to 16 measurement programs
- Data-logger for up to 30.000 measured values
- DAkKS/factory calibration certificate available for the instrument or the entire measurement chain including 8527 reference sensor (optional)

### ADJUSTMENT FOR USE WITH EXTERNAL INSTRUMENTS

When planning to connect display and analysis instruments to your load cell, it is essential to calibrate the system, i.e. align the sensor with the instruments, to ensure correct measurement readings and correct output scaling. We are happy to perform this **adjustment of sensor and indicator** for you, and supply a **traceable adjustment report** with this service. We can also accommodate personal adjustment requirements. This service means that your measurement system is immediately ready for use, saving you precious time.

### PROCESS MONITORING CONTROLLER

Process controllers are used when **detailed process analysis for continuous optimization and zero-fault monitoring** of the produced parts is needed in addition to sensor signal amplification, visualization and recording. The powerful burster controllers are designed for the demands of an exacting production system usually involving partial or full automation. A vast range of applications can be analyzed and monitored thanks to high-speed and synchronous measurement data acquisition and a wealth of measurement and evaluation techniques. These tools provide the user with detailed process information. The **smart process monitoring systems** visualize, analyze and evaluate quality-relevant process parameters, and can transmit the results **via the latest communications interfaces**. **Ethernet-based fieldbus systems** such as PROFINET transfer process results and status messages to higher-level controllers in real time. Whatever the movement or joining system – pneumatic, hydraulic or servo-electric – burster process controllers have the versatility to integrate with all forms of motion technology.

**DIGIFORCE®** monitors processes in which precisely defined functional relationships need to be demonstrated between two or more measured quantities of the process. Recording, visualizing and evaluating the X/Y curve allow 100% monitoring of process quality, ensuring that the production step and every single produced part are checked.

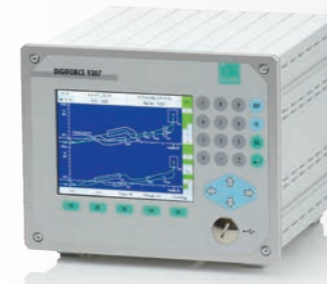

#### DIGIFORCE® 9307

- Greatest precision for the toughest demands
- Simultaneous monitoring of two synchronous processes
- 128 measurement programs for a large variety of parts
- High measurement accuracy 0.05 % F.S. possible at 10 kHz sampling rate
- Intelligent signal sampling through combination of  $\Delta t$ ,  $\Delta X$ ,  $\Delta Y$
- Ultra-fast evaluation (15 ms) and data transfer for dynamic measurements
- Fieldbus data logging in real time
- USB service interface on the front
- Automatic sensor recognition due to burster TEDS



#### DIGIFORCE® 9311

- Simple, quick setup on colour display with touch operation
- 16 measurement programs
- USB service interface on the front
- Fieldbus data logging in real time
- Display and analysis of last 50 measurements
- Universal multi-range measurement channels
- Quick USB data logging
- Automatic sensor recognition due to burster TEDS

The **ForceMaster 9110** has been developed specifically for monitoring manual lever presses. So easy to operate, it lets any user monitor the press operation successfully.



#### ForceMaster 9110

- Excellent value "Plug & Work" complete system
- Easy auto-configuration with automatic setting of the evaluation tools
- Smart Card system for manipulation free configuration and storage of settings
- Acoustic and optic error indication
- Data logging on USB flash drive (optional)
- PLC sequence control function (optional)
- Includes analysis and configuration software
- Automatic sensor recognition
- Hub and other component counters

### EXPERTS IN EVERY FIELD

**burster instrumentation amplifiers, digital indicators, calibrators and process controllers are incredibly versatile.** They enjoy the trust of countless users in industries with extremely high quality standards; industries such as mechanical and plant engineering, automation and the automotive sector and its suppliers. And in increasingly important markets such as medical technology, biotechnology, e-mobility and drive technology, burster systems are already making a vital contribution to quality assurance.

# Calibration services in manufacturer quality

CERTIFIED QUALITY WITH DAkkS/FACTORY CALIBRATION AND TEST CERTIFICATES.

# Flexible service that fits your business

AT YOUR SERVICE!



## PROVIDING TAILORED CALIBRATION SERVICES

As a manufacturer of sensors and measuring systems, burster also features a calibration laboratory accredited to DIN EN ISO/IEC 17025:2005 for the measured mechanical quantity of force.



## IN-HOUSE CALIBRATION SERVICES

For force as the measured quantity, we offer not only test & alignment reports and factory calibration certificates but also the option of a German-accredited DAkkS calibration certificate. burster's fast and efficient calibration service delivers outstanding reliability, accuracy, rigour and traceability for every calibration.

Sample of Calibration Services	Measuring Range	Test & Calibration Certificate	Factory Lab	DAkkS Lab
<b>Force (compressive load DIN EN ISO 376)</b>				
Load cell and force measuring chain	20 N	■	■	■ *
	100 N ... 500 N	■	■	■
	1 kN ... 2 kN	■	■	■ *
	5 kN ... 50 kN	■	■	■
	100 kN ... 2 MN	■	■ *	■ *
<b>Force (tensile load DIN EN ISO 376)</b>				
Load cell and force measuring chain	1 N ... 50 kN	■	■	■ *
	100 kN ... 1 MN	■	■ *	■ *

\* external partners

### The calibrations carried out include the following services:

- Assessing whether your test and measuring equipment is suitable for calibration
- Performing a calibration
- Documenting the calibration with a factory/DAkkS calibration certificate
- Labelling the calibration items in accordance with ISO 17025 or German DKD-5 requirements

Should it prove during our calibration-suitability check that an adjustment is necessary, we perform this adjustment prior to calibration in close consultation with you.

## TAKE ADVANTAGE

You want to be sure that your technical planning is cost-effective and on schedule without the administrative bother of handling your recurring calibration jobs. Then take advantage of our extremely attractive range of calibration offers! We make sure our service meets your needs in terms of schedule, requirements and level of calibration service.

As a German-accredited DAkkS calibration laboratory and manufacturer, we are at your service for calibration, testing and adjustment of your test and measurement equipment in accordance with relevant standards or your own requirements, either in our

own laboratory or at your site. We can provide the optimum calibration service for practically any task.

Check online at [www.burster.com](http://www.burster.com) to find your regional contact who will consult and support you individually.

## ON-SITE CALIBRATION

Make use of our years of experience to perform regular testing and calibration at your site.

- You expect your test equipment to be monitored in accordance with ISO 9001?
- You don't have the resources to dismantle the machinery/equipment for calibrations?
- You want to keep your machinery downtimes to the minimum?

### Our on-site calibration service includes:

- Checking your test or measuring equipment
- Calibration to traceable reference standards
- Providing calibration certification including labelling the calibrated equipment
- Adjustment of amplifiers and measuring systems

## START SELF-GOVERNING YOUR NEEDS WITH OUR SMART CALIBRATION SOLUTIONS

If for any reason an on-site service through us or our partners isn't possible, we offer you some very attractive alternatives to help you calibrate your force measurement system yourself.

### Compact and user-friendly portable load-cell calibrator 72KME

- Force measuring ranges from 0 ... 50 kN
- System accuracy of 0.3 % F.S.
- Full range of accessories, calibration software, reference measurement chains with DAkkS calibration certificate

### Portable reference force measuring chain including DAkkS certificate 72-REF

- 12 force measuring ranges from 0 ... 20 N up to 100 kN
- Maximum, traceable precision

## TRANS CAL 7281 PRECISION CALIBRATION IN YOUR HANDS



Our unique mobile high-precision calibrator and testing device is the smart, robust and traceable answer to your calibration requirements.

TRANS CAL 7281 allows mobile calibration by yourselves on site, with a high degree of accuracy and without needing to dismantle equipment.



Reference measurement chain in combination with a reference sensor



Device test/strain gage simulator  
Infinitely adjustable simulation values: up to ±50 mV/V, up to 10 VDC  
Measurement:  $U_{supply}$  up to 10 VDC



Sensor test  
 $R_r$ ,  $R_a$ , Shunt,  $R_{ISO}$

THE MEASUREMENT SOLUTION.

**burster**

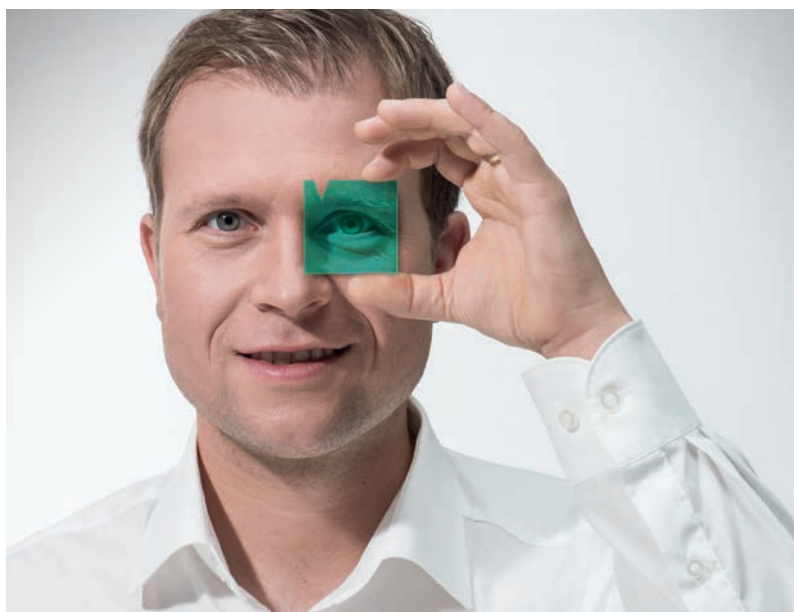
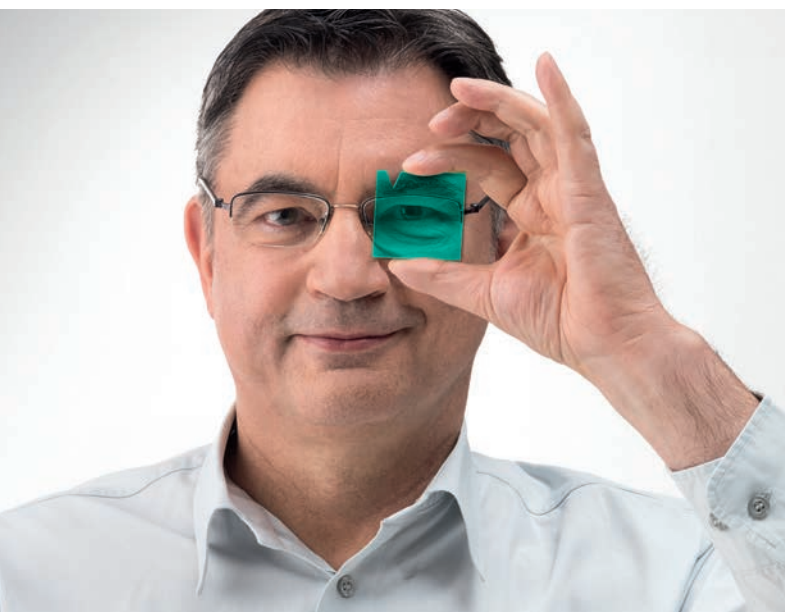

**BECAUSE PROGRESS NEEDS VISION.**

burster, the specialist for measuring equipment and sensors, delivers the ideal solution that meets your requirements to a T. We offer you forward-looking products, system solutions and a comprehensive suite of services to supplement our product range. With personal commitment and an uncompromising focus on quality.

# Measuring technology with perspective.

burster praezisionsmesstechnik  
gmbh & co kg  
Talstr. 1-5  
76593 Gernsbach, GERMANY

Phone: +49-7224-645-0  
Fax: +49-7224-645-88  
Email: [info@burster.com](mailto:info@burster.com)  
[www.burster.com](http://www.burster.com)

THE MEASUREMENT SOLUTION.

**burster**