

1.1	Hochleistungsheizpatronen <i>High-Density Cartridge Heaters</i>	2-7
1.2	Optionen (Thermofühler, Anschluss,...) <i>Options (Thermo Sensors, Connection,...)</i>	8-17
1.3	Verdichtete Heizpatronen <i>Medium-Density Cartridge Heaters</i>	18
1.4	Kleinspannungsheizpatronen <i>Low Voltage Cartridge Heaters</i>	19
1.5	Quadratische Heizpatronen <i>Square Cartridge Heaters</i>	20
1.6	Service (Benutzerhinweise, Anfrageformular) <i>Service (User Manual, Inquiry form)</i>	21-23



Heizpatronen sind preiswert, robust und montagefreundlich. Sie bestehen i.d.R. aus einem zylindrischen Metallkörper aus Edelstahl und bieten dadurch einen hohen Korrosionsschutz. Innenliegend befindet sich eine Heizwendel, die auf einen Keramikern aufgewickelt ist. Je nach Leistung variiert die Anzahl der Heizleiter-Windungen. Um einen Kurzschluss zwischen Heizleiter und Metallkörper zu vermeiden, wird die Heizpatrone mit Magnesiumoxid befüllt und anschließend verdichtet. Hochverdichtet werden Heizpatronen mit bis zu 50 W/cm² gefertigt und halten höchsten Belastungen stand.

Neben unserem breiten Standardangebot entwickeln und fertigen wir gerne auch nach Ihren speziellen Vorgaben.

Cartridge heaters are reasonably priced, robust and easy to install. As a rule they consist of a cylindrical stainless steel tube and thus provide a high corrosion prevention. There is a heating wire inside which is wound onto a ceramic core. The number of coils varies depending on the power. In order to avoid a short-circuit, the cartridge heater is filled with magnesium oxide and compressed afterwards. Highly compacted they reach a surface watt density of up to 50 W/cm² and withstand highest stress.

Apart from our broad standard range we also develop and manufacture cartridge heaters according to your special demands.

1.1 Hochleistungsheizpatronen
High-Density Cartridge Heaters

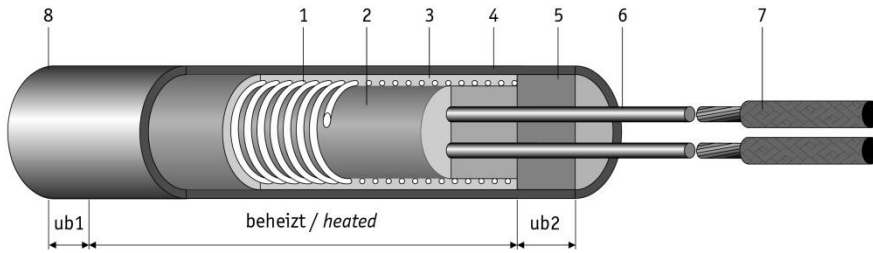

ub = unbeheizt / unheated

ub1 ≈ 0,5 x Ø (min. 4mm)

ub2 ≈ 1 x Ø

ub2 ≈ 2 x Ø (bei Anschlussstyp I & Ø ≥ 3/8" bzw. ≥ 10mm / at connection type I & Ø ≥ 3/8" resp. ≥ 10mm)

1 Heizleiter in Qualität NiCr 80/20

2 Wickelkörper aus MgO

3 Hochverdichtetes reines MgO

4 Edelstahlmantel

5 Keramischer Kopf

6 Nickelanschlussdrähte

7 Glasfaserisolierte Reinnickellitze

8 WIG-geschweißte Bodenscheibe

1 Nickel-chrome 80/20 resistance wire

2 Magnesium oxide core

3 High purity compacted magnesium oxide

4 Stainless steel sheath

5 Ceramic end cap

6 Solid nickel conductors

7 Fiberglass-silicone insulated nickel leadwires

8 Tig welded bottom disc



- Standard-Anschlussausführung(en) → siehe Abb. 0-1 bis Abb. 0-3
- Standard-Durchmesser, -Längen und -Leistungen → siehe nachstehende Tabellen
- Optionen → siehe Kapitel 1.2
- Standard connection(s) → see Abb. 0-1 to Abb. 0-3
- Standard diameters, length and power → see following tables
- Options → see chapter 1.2

Hochleistungsheizpatronen zeichnen sich durch ihre hohe Verdichtung und damit besonders effiziente Wärmeabgabe aus. Deshalb produzieren wir sie ausschließlich mit einer geschliffenen Oberfläche für eine Bohrung mit H7 Toleranzfeld. Der Heizleiter wird wie auf dem Foto dargestellt auf einen keramischen Wickelkörper gespult. Anschließend wird der Zwischenraum zum Patronenmantel mit MgO verfüllt. Zum Abschluss wird die Patrone umlaufend reduziert und damit verdichtet. Der Vorteil dieses Aufbaus liegt in der geringen Distanz des Heizleiters zum Mantel und der daraus resultierenden sehr guten Wärmeübertragung sowie einem sehr guten Regelverhalten.

High-density cartridge heaters distinguish themselves by their high compression and therefore especially efficient heat emission. That's why we produce them with a ground surface for a drill hole with H7 tolerance zone. The resistance wire is spooled on a ceramic core as shown on the photograph. Afterwards the space between wire and cartridge sheath is filled with MgO. Finally the cartridge is swaged and thus compressed. Advantage of this construction is the resistance wire's short distance to the sheath, the resulting very good heat emission and the excellent control response.

Technische Daten und Toleranzen:
(Aus dieser Tabelle können keine Garantiansprüche abgeleitet werden)

Leistung:	+ 5% -10%									
Widerstand:	+10% -5%									
Hochspannungsfestigkeit:	1500 V									
Isolationswiderstand (bei 500 V DC):	> 10 MΩ									
Ableitstrom (kalt):	< 0,5 mA									
Max. Arbeitstemperatur:	750 °C									
Längentoleranz:	±2% (min. ±1 mm)									
Ø in mm	4	5	6,5 1/4"	8	10 3/8"	12,5 1/2"	16 5/8"	20 3/4"	25* 1"	32* 1 1/4"*
max V	240	240	240	240	240	240	400	400	400	400
(Sonderspannungen auf Anfrage)										
max A	2	2,5	4	5	8	14	18	22	25	25

* nur auf Anfrage
Ø 25 mm / 1": L_{min} 150 mm, L_{max} 1500 mm
Ø 32 mm / 1 1/4": L_{min} 300 mm, L_{max} 2000 mm







Technical data and tolerances:
(No warranty claims can be derived from this table)

Wattage:	+ 5% -10%									
Resistance:	+10% -5%									
Dielectric strength (voltage applied):	1500 V									
Insulation (cold 500 V DC):	> 10 MΩ									
Leakage current (cold):	< 0,5 mA									
Max. working temperature allowed on sheath:	750 °C									
Length tolerance:	±2% (min. ±1 mm)									
Ø in mm	4	5	6,5 1/4"	8	10 3/8"	12,5 1/2"	16 5/8"	20 3/4"	25* 1"	32* 1 1/4"*
max V	240	240	240	240	240	240	400	400	400	400
(special voltage on request)										
max A	2	2,5	4	5	8	14	18	22	25	25

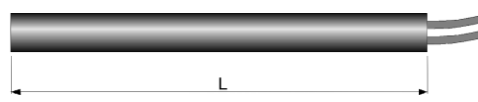
* on request
Ø 25 mm / 1": L_{min} 150 mm, L_{max} 1500 mm
Ø 32 mm / 1 1/4": L_{min} 300 mm, L_{max} 2000 mm

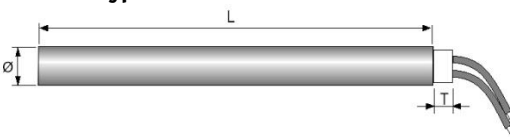

Standard-Anschluss / standard connection

<p>Abb. 0-1: Type I</p> 		<p>Die elektrische Kontaktierung erfolgt „im Inneren“ der Heizpatrone (max. Leitungslänge unverlängert 1000 mm bis Ø 8 mm) Vorteil: flexibler Abgangsbereich</p> <p><i>Electric contact is made „Inside“ the cartridge heater (max. lead length uncoupled 1000 mm up to Ø 8 mm)</i> <i>Advantage: flexible termination area</i></p>															
<p>Abb. 0-2: Type N</p> 		<p>Die Normale elektrische Kontaktierung erfolgt außerhalb der Heizpatrone und liegt geschützt im Silikon imprägnierten Glaseisenschlauch Vorteil: kostengünstige Herstellung, frei wählbare Leitungslänge</p> <p><i>The Normal electric contact is made outside the cartridge heater and is protected by a silicone impregnated fibre glass sleeve</i> <i>Advantage: cheap production, length of the lead freely selectable</i></p>															
<p>Abb. 0-3: Type F</p>  <table border="1" data-bbox="191 907 734 996"> <tr> <td>Ø</td> <td>3/8"</td> <td>1/2"</td> <td>5/8"</td> <td>3/4"</td> </tr> <tr> <td></td> <td>10 mm</td> <td>12,5 mm</td> <td>16 mm</td> <td>20 mm</td> </tr> <tr> <td>T [mm]</td> <td>5</td> <td>6</td> <td>7</td> <td>8</td> </tr> </table>	Ø	3/8"	1/2"	5/8"	3/4"		10 mm	12,5 mm	16 mm	20 mm	T [mm]	5	6	7	8		<p>Die Flexible Variante der außen kontaktierten „Normalausführung“ Typ N Vorteil: Verbindungsstelle liegt geschützt vor Biegebeanspruchung in einer Keramikendkappe, aus Lagerpatronen herstellbar, frei wählbare Leitungslänge</p> <p><i>Flexible version of the outside contacted "normal" connection type N</i> <i>Advantage: Connection is protected from bending in a ceramic cap, can be manufactured of stock cartridge heaters, length of the lead freely selectable</i></p>
Ø	3/8"	1/2"	5/8"	3/4"													
	10 mm	12,5 mm	16 mm	20 mm													
T [mm]	5	6	7	8													

Standard-Anschlussleitung:

250 mm glasseidenisolierte Reinnickellitze (bis 300°C Dauertemperaturbeständig)
 bei Hochleistungsheizpatronen Ø 4,0 mm PTFE-Litze (bis 260°C Dauertemperaturbeständig)
 (Mit Thermofühler: 1000 mm)
 (Thermoausgleichsleitungen siehe Kapitel 1.2)

Standard leads:

250 mm fibre glass insulated nickel leads (up to 300°C permanent temperature resistant)
 for High-Density Cartridge Heaters Ø4,0 mm PTFE leads (up to 260°C permanent temperature resistant)
 (With thermocouple: 1000 mm)
 (thermo leads see chapter 1.2)

Ø [mm / ""]	4,0	5,0	6,5 1/4"	8	10 3/8"	12,5 1/2"	16 5/8"	20 3/4"	Legende legend S = Standard O = Option
I	S	S	S	S	O	O	O	O	
N	-	-	-	-	S	S	S	S	
F	-	-	-	-	O	O	O	O	

Standardpatronen (metrisch) / standard cartridge heaters (metric)

∅ mm	L mm	W 230V	W/cm ²	TC
4*	30	50	20	-
		75	30	-
-0,02	35	60	19	-
		90	29	-
-0,04	40	70	19	-
		105	28	-
45	80	80	18	-
		120	27	-
		135	27	-
50	90	90	18	-
		135	27	-
55	100	100	18	-
		150	27	-
60	110	110	18	-
		165	26	-
70	130	130	17	-
		195	26	-
80	150	150	17	-
		225	26	-

∅ mm	L mm	W 230V	W/cm ²	TC
5*	30	100	42	x
		125	53	x
-0,02	40	100	26	x
		160	41	x
-0,04	50	100	18	x
		160	29	x
60	125	125	18	x
		200	28	x
80	125	125	12	x
		200	20	x
100	160	160	12	x
		250	19	x
130	200	200	11	x
		315	18	x

* Patronen gelten bei der Preisfindung als Sonderpatronen

* The cartridge heaters are to be considered as special for the pricing

∅ mm	L mm	W 230V	W/cm ²	TC
6,5	40	80	15	-
		100	18	-
-0,02	125	125	22	x
		160	28	x
-0,04	200	200	36	x
		315	42	-
50	125	125	16	x
		160	21	x
		200	26	x
50	250	250	32	-
		315	42	-
		400	52	-
60	125	125	13	-
		160	17	x
		200	21	x
60	250	250	26	x
		315	33	-
		400	44	-
80	160	160	12	-
		200	15	x
		250	19	x
80	315	315	24	x
		400	32	-
		500	42	-
100	200	200	12	-
		250	15	x
		315	18	x
		400	24	x
130	250	250	11	-
		315	13	x
		400	17	x
		500	22	x
160	250	250	9	-
		315	11	x
		400	14	x
		500	18	x

∅ mm	L mm	W 230V	W/cm ²	TC
8	40	125	18	-
		160	23	x
-0,03	200	200	30	x
		315	42	-
-0,05	50	125	14	-
		160	18	x
50	200	200	22	-
		250	28	x
		400	44	-
60	160	160	14	-
		200	17	x
		250	22	-
		315	27	x
80	200	200	12	-
		250	15	x
		315	19	x
		400	24	x
100	200	200	9	-
		250	12	x
		315	14	-
		400	18	x
130	250	250	9	-
		315	11	x
		400	14	-
		500	18	x
160	250	250	7	-
		315	9	x
		400	11	-
		500	14	x

∅ mm	L mm	W 230V	W/cm ²	TC
10	40	125	16	-
		160	20	x
		200	25	x
		250	32	x
		315	39	-
50	160	160	15	-
		200	18	x
		250	23	x
		315	28	x
		400	36	-
60	160	160	12	-
		200	15	x
		250	18	x
		315	23	x
		400	30	-
80	200	200	10	-
		250	13	x
		315	16	x
		400	20	x
		500	26	-
100	250	250	10	-
		315	12	x
		400	16	x
		500	20	x
		630	32	-
130	250	250	7	-
		315	9	x
		400	12	x
		500	14	x
		630	18	-
160	315	315	7	-
		400	9	x
		500	11	x
		630	14	x
		800	18	-
200	400	400	7	-
		500	9	x
		630	11	-
		800	14	x
		1000	18	-

Lagerpatrone / stock cartridge heater

Ø mm	L mm	W 230V	W/cm ²	TC
12,5	40	160	16	-
		200	20	x
		250	25	x
		315	32	-
	50	160	11	-
		200	14	x
		250	18	-
		315	22	x
		400	28	x
		500	35	-
	60	200	11	-
		250	14	x
		315	18	-
		400	22	x
		500	28	-
	80	200	8	-
		250	10	x
		315	13	-
		400	16	x
		500	20	-
		630	25	-
		800	32	-
	100	315	10	-
		400	12	x
		500	15	-
		630	19	x
		800	24	-
		1000	30	-
		1250	37	-
	130	315	7	-
		400	9	x
		500	11	-
		630	14	x
		800	18	-
		1000	22	-
	160	400	7	-
		500	9	x
		630	11	-
		800	14	x
		1000	18	-
		1250	22	-
	200	500	7	-
		630	9	x
		800	11	-
		1000	14	x
		1250	17	-
		1600	22	-
		2000	28	-
250	630	7	-	
	800	9	x	
	1000	11	-	
	1250	13	x	
	1600	18	-	
	2000	22	-	
	2500	28	-	
300	630	6	-	
	800	7	-	
	1000	9	x	
	1250	11	-	
	1600	15	x	
	2000	18	-	

Ø mm	L mm	W 230V	W/cm ²	TC
16	50	200	12	-
		250	15	-
		315	19	-
		400	24	-
	60	200	9	-
		250	11	-
		315	14	-
		400	18	-
		500	22	-
		630	28	-
	80	250	8	-
		315	10	-
		400	13	-
		500	16	-
		630	20	-
		800	26	-
		1000	32	-
	100	315	8	-
		400	10	-
		500	12	-
		630	15	-
		800	20	-
		1000	24	-
		1250	30	-
	130	400	7	-
		500	9	-
		630	11	-
		800	14	-
		1000	18	-
		1250	22	-
	160	500	7	-
		630	9	-
		800	11	-
		1000	14	-
		1250	18	-
		1600	22	-
	200	630	7	-
		800	9	-
		1000	11	-
		1250	14	-
		1600	18	-
		2000	22	-
		2500	28	-
		3000	35	-
		3500	42	-
		4000	50	-
	250	630	5	-
		800	7	-
		1000	9	-
		1250	11	-
		1600	14	-
		2000	18	-
2500		22	-	
3000		28	-	
3500		35	-	
4000		42	-	
300	800	6	-	
	1000	7	-	
	1250	9	-	
	1600	11	-	
	2000	14	-	
	2500	18	-	
	3000	22	-	
	3500	28	-	
	4000	35	-	
	4500	42	-	
350	800	5	-	
	1000	6	-	
	1250	8	-	
	1600	10	-	
	2000	12	-	
	2500	16	-	
	3000	20	-	
400	800	4	-	
	1000	5	-	
	1250	6	-	
	1600	8	-	
	2000	10	-	
	2500	13	-	
	3000	16	-	

Ø mm	L mm	W 230V	W/cm ²	TC
20	80	400	11	-
		500	14	-
		630	17	-
	100	400	8	-
		500	10	-
		630	13	-
	130	500	7	-
		630	9	-
		800	12	-
		1000	15	-
		1250	19	-
	160	630	7	-
		800	9	-
		1000	11	-
		1250	14	-
		1600	19	-
	200	800	7	-
		1000	9	-
		1250	11	-
		1600	14	-
		2000	18	-
	250	1000	7	-
		1250	9	-
		1600	11	-
		2000	14	-
		2500	18	-
	300	1000	6	-
		1250	7	-
1600		9	-	
2000		11	-	
2500		14	-	
350	1250	6	-	
	1600	8	-	
	2000	10	-	
	2500	12	-	
	3000	16	-	
400	1250	5	-	
	1600	7	-	
	2000	9	-	
	2500	11	-	
	3000	14	-	
500	1600	5	-	
	2000	6	-	
	2500	8	-	
	3000	10	-	
	3500	13	-	

Lagerpatrone / stock cartridge heater

Als Sonderausführung verfügbare Durchmesser (auf Anfrage):
 Ø 5,9 / 6 / 6,4 / 12 / 14 / 15 / 18 / 25 / 25,4 / 31,8 mm
 quadratisch: 4,5x4,5 / 6x6 / 8x8 / 6x12 / 10x10 mm
 (siehe Kap. 1.5)

Also available special diameters (on request):
 Ø 5,9 / 6 / 6,4 / 12 / 14 / 15 / 18 / 25 / 25,4 / 31,8 mm
 square: 4,5x4,5 / 6x6 / 8x8 / 6x12 / 10x10 mm
 (see chapter 1.5)

Standardpatronen (Zoll) / standard cartridge heaters (inch)

Ø	L	W	W/cm ²	TC	
1/4" 6,35 mm	1" 25,4 mm	230V	38	-	
		100	38	-	
	1 1/4" 31,8 mm	100	25	-	
			125	31	x
			160	40	x
	1 1/2" 38,1 mm	80	15	-	
			100	18	-
			125	23	x
	2" 50,8 mm	125	17	-	
			160	21	x
			200	27	x
	2 1/2" 63,5 mm	125	13	-	
			160	16	-
			200	20	x
	3" 76,2 mm	160	13	-	
			200	16	x
			250	20	x
	3 1/2" 88,9 mm	160	11	-	
			200	13	x
			250	17	x
	4" 101,6 mm	200	11	-	
			250	14	x
			315	18	x
	5" 127 mm	250	11	-	
			315	14	x
			400	18	x
	6" 152,4 mm	250	9	-	
			315	12	x
400			15	x	

Ø	L	W	W/cm ²	TC	
3/8" 9,52 mm	1" 25,4 mm	230V	28	-	
		125	28	-	
	1 1/4" 31,8 mm	125	21	-	
			200	33	x
	1 1/2" 38,1 mm	125	17	-	
			160	21	x
			200	27	x
			250	33	x
	1 3/4" 44,5 mm	125	13	x	
			160	17	x
			200	21	x
			250	26	x

2" 50,8 mm	150	15	-		
		200	19	x	
		250	24	x	
		315	30	x	
	160	38	-		
		400	38	-	
		2 1/2" 63,5 mm	160	11	-
				200	14
	250			17	x
	315			22	x
	160	28	x		
		400	28	x	
500		34	-		
3" 76,2 mm		200	11	-	
	250		14	x	
	315		18	x	
	400		22	x	
160	28	x			
	500	28	x		
	630	45	-		
	3 1/2" 88,9 mm	200	9	-	
250			11	x	
315			14	x	
400			18	x	
160	23	x			
	500	23	x		
	630	29	-		
	4" 101,6 mm	250	10	-	
315			12	x	
400			16	x	
500			20	x	
160	25	-			
	800	32	-		
	5" 127 mm	250	7	-	
			315	9	-
400			12	x	
500			15	x	
160	18	-			
	800	24	-		
	6" 152,4 mm	315	8	-	
			400	10	x
500			12	x	
630			15	x	
160	20	-			
	1000	24	-		
	7" 177,8 mm	400	8	-	
			500	10	x
630			13	-	
800			16	x	
160	21	-			
	1000	21	-		
	8" 203,2 mm	400	7	-	
			500	9	x
630			11	-	
800			18	x	
160	23	-			

Ø	L	W	W/cm ²	TC	
1/2" 12,7 mm	1 1/2" 38,1 mm	230V	18	-	
		160	18	-	
		200	22	x	
		250	28	x	
	160	35	-		
		315	35	-	
		2" 50,8 mm	160	11	-
				200	14
250	18			-	
315	22			x	
160	28	-			

2 1/2" 63,5 mm	200	10	-	
		250	13	x
		315	16	-
		400	20	x
		500	26	-
3" 76,2 mm	250	10	x	
		315	13	-
		400	16	x
		500	20	-
		630	26	-
3 1/2" 88,9 mm	250	9	-	
		315	11	x
		400	14	x
		500	18	x
		630	22	-
4" 101,6 mm	315	9	-	
		400	12	x
		500	15	x
		630	18	x
		800	24	-
5" 127 mm	315	7	-	
		400	9	x
		500	11	-
		630	14	x
		800	18	x
6" 152,4 mm	400	7	-	
		500	9	x
		630	12	-
		800	15	x
		1000	18	-
7" 177,8 mm	400	6	-	
		500	8	x
		630	10	-
		800	12	x
		1000	16	-
8" 203,2 mm	500	7	-	
		630	8	x
		800	11	-
		1000	14	x
		1250	17	-
9" 228,6 mm	500	6	-	
		630	8	x
		800	10	-
		1000	12	x
		1250	15	-
10" 254 mm	630	7	-	
		800	9	x
		1000	11	-
		1250	13	x
		1600	17	x
12" 304,8 mm	630	6	-	
		800	7	-
		1000	9	x
		1250	11	-
		1600	14	x
2000	18	-		

Ø	L	W	W/cm²	TC	
		230V			
5/8'' 15,87 mm	2''	200	11	-	
		250	14	-	
		315	18	-	
	-0,05	50,8 mm	400	23	-
			200	8	-
			250	10	-
			315	13	-
	-0,08	63,5 mm	400	16	-
			500	20	-
			250	8	-
			315	11	-
			400	13	-
3''	76,2 mm	500	17	-	
		630	21	-	
		800	26	-	
		315	8	-	
		400	10	-	
		500	12	-	
4''	101,6 mm	630	15	-	
		800	20	-	
		1000	24	-	
		400	7	-	
		500	8	-	
5''	127 mm	630	10	-	
		800	14	-	
		1000	17	-	
		1250	21	-	
		500	7	-	
6''	152,4 mm	630	9	-	
		800	12	-	
		1000	15	-	
		1250	19	-	
		1600	24	-	
		500	6	-	
7''	177,8 mm	630	8	-	
		800	10	-	
		1000	13	-	
		1250	16	-	
		1600	20	-	
8''	203,2 mm	630	7	-	
		800	9	-	
		1000	11	-	
		1250	14	-	
		1600	18	-	
10''	254 mm	2000	22	-	
		630	5	-	
		800	7	-	
		1000	9	-	
		1250	11	-	
12''	304,8 mm	1600	14	-	
		2000	17	-	
		800	6	-	
		1000	7	-	
		1250	9	-	
14''	355,6 mm	1600	11	-	
		2000	14	-	
		800	5	-	
		1000	6	-	
		1250	7	-	
16''	406,4 mm	1600	9	-	
		2000	12	-	
		2500	15	-	
		800	5	-	

16'' 406,4 mm	1000	5	-
	1250	6	-
	1600	8	-
	2000	10	-
	2500	12	-

Ø	L	W	W/cm²	TC
		230V		
3/4'' 19,05 mm	3''	400	11	-
		500	14	-
		630	18	-
-0,06	76,2 mm	400	8	-
		500	10	-
		630	13	-
-0,1	101,6 mm	500	7	-
		630	9	-
		800	11	-
5''	127 mm	1000	14	-
		630	8	-
		800	10	-
6''	152,4 mm	1000	13	-
		1250	16	-
		800	7	-
		1000	9	-
		2000	14	-
8''	203,2 mm	2000	14	-
		1000	9	-
		1250	11	-
		1600	15	-
10''	254 mm	1600	11	-
		2000	14	-
		1000	7	-
12''	304,8 mm	1250	9	-
		2000	12	-
		1000	6	-
		1250	7	-
14''	355,6 mm	1600	9	-
		2000	12	-
		1250	6	-
16''	406,4 mm	1600	8	-
		2000	10	-
		2500	13	-
		1250	5	-
18''	457,2 mm	1600	7	-
		2000	9	-
		2500	11	-
		3200	12	-
20''	508 mm	1600	6	-
		2000	7	-
		2500	9	-
		3200	11	-

Als Sonderausführung verfügbare Durchmesser (auf Anfrage):
 Ø 5,9 / 6 / 6,4 / 12 / 14 / 15 / 18 / 25 / 25,4 / 31,8 mm
 quadratisch: 4,5x4,5 / 6x6 / 8x8 / 6x12 / 10x10 mm
 (siehe Kap. 1.5)

Also available special diameters (on request):
 Ø 5,9 / 6 / 6,4 / 12 / 14 / 15 / 18 / 25 / 25,4 / 31,8 mm
 square: 4,5x4,5 / 6x6 / 8x8 / 6x12 / 10x10 mm
 (see chapter 1.5)

1.2 Optionen Options





Folgende **Optionen** müssen (falls gewünscht) in Anfrage und Bestellung gesondert spezifiziert werden:

- Thermofühler (Typ, Position)
- Anschluss (Anschlusslitze, Feuchtigkeitsschutz, Schutzleiter)
- Abgang (Winkelabgang, Einschraubnippel, Flansch, Sicherungsring, Zapfen)
- Schutzschlauch
- Leistungsverteilung

Following **options** (if required) are to be specified in inquiry and order:

- Thermo Sensors (type, position)
- connection (leads, moisture protection, earth lead)
- termination (right angle exit, hexagon head, flange, stop ring, pin)
- protection sleeve
- differential power



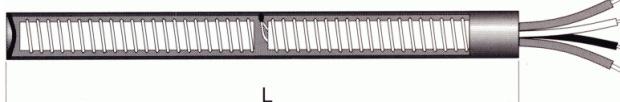
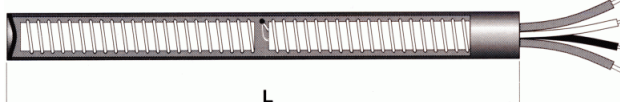

Thermofühler / thermo sensors

<p>Abb. 0-4: Type TC1 (Standard!)</p> 	<p>Messpunkt auf Höhe des Patronenbodens am Mantel geerdet Vorteil: kurze Reaktionszeit <i>Hot junction grounded to the bottom disc</i> Advantage: quick response</p>
<p>Abb. 0-5: Type TC2</p> 	<p>Messpunkt auf Höhe des Patronenbodens nah am Mantel (potentialfrei) Vorteil: geringere Stöempfindlichkeit <i>Hot junction ungrounded near bottom disc</i> Advantage: little prone to interferences</p>
<p>Abb. 0-6: Type TC3</p> 	<p>Messpunkt ist mittig in der beheizten Zone am Patronenmantel geerdet Vorteil: kurze Reaktionszeit Hinweis: Die Länge der Patrone muss mindestens 80mm sein <i>Hot junction grounded to the sheath in the middle of the heated zone</i> Advantage: quick response Please note: The length of the cartridge must be at least 80mm</p>
<p>Abb. 0-7: Type TC4</p> 	<p>Messpunkt liegt potentialfrei mittig in der beheizten Zone nah am Patronenmantel Vorteil: geringe Stöempfindlichkeit Hinweis: Die Länge der Patrone muss mindestens 50mm sein <i>Hot junction is ungrounded near the sheath in the middle of the heated zone</i> Advantage: little prone to interferences Please note: The length of the cartridge must be at least 50mm</p>

DIN 43714			empfohlene Einsatztemperatur Recommended temperature	TC1	TC2	TC3	TC4
Type	+	-					
J	Rot / red (Fe)	Blau / blue (CuNi)	< 500°C	x (Standard)	x	x	x
K	Rot / red (NiCr)	Grün / green (Ni)	< 750°C	x	x	x	x

Standard-Thermolitze: 1000 mm, PTFE-isoliert
 Standard thermo leads: 1000 mm, PTFE insulated

Anschluss / connection

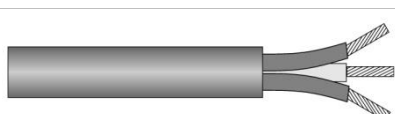

	Anschlusslitze	leads
	Standard: Glasseidenisolierte Reinnickellitze bis 300°C	<i>Standard:</i> Fibre glass insulated nickel leads up to 300°C
	PTFE-isolierte Reinnickellitze bis 260°C <u>Vorteil:</u> feuchtigkeitsdicht	PTFE insulated nickel leads up to 260°C <i>Advantage:</i> moisture tight
	Hochtemperaturlitze bis 500°C <u>Vorteil:</u> hoch temperaturbeständig	High temperature leads up to 500°C <i>Advantage:</i> highly temp. resistant
	Silikon-isolierte vernickelte Kupferlitze (nur mit Standardanschluss Typ N → siehe Kapitel 1.1) bis 180°C <u>Vorteil:</u> flexibel, feuchtigkeitsdicht	Silicone insulated nickel plated copper leads (available only with standard connection type N → see chapter 1.1) up to 180°C <i>Advantage:</i> flexible, moisture tight
	Silikonkabel (2-/3-polig) bis 180°C	Silicone cable (bi-tripolar) up to 180°C

Feuchtigkeitsschutz

Anstelle den Patronenabgang mit Keramikzement zu vergießen oder mit einem Keramikkopf zu versehen (vgl. Standard-Anschlüsse in Kapitel 1.1) können alternativ auch Verschlussarten hergestellt werden, die einen besonderen Feuchtigkeitsschutz bieten.

moisture protection

Instead of sealing the termination with ceramic cement or installing a ceramic cap (→ see standard connections in chapter 1.1) we can alternatively produce other kinds of terminations which provide a special moisture protection.

	<p>Abb. 0-8: PTFE</p> <p>Mit einer einreduzierten PTFE-Scheibe verschlossene Heizpatronen sind bis 260°C dauer-temperaturbeständig und sollten in Verbindung mit PTFE-isolierter Anschlusslitze zum Einsatz kommen. <u>Vorteil:</u> feuchtigkeitsgeschützt</p> <p><i>Cartridge heaters with a PTFE disk are permanent temperature resistant up to 260°C and should be used in connection with PTFE insulated leads.</i> <i>Advantage:</i> moisture protected</p>
	<p>Abb. 0-9: Silicone</p> <p>Mit Silikon vergossene Heizpatronen sind bis 180°C temperaturbeständig und sollten in Verbindung mit Silikon-isolierter Anschlusslitze verwendet werden. <u>Vorteil:</u> feuchtigkeitsgeschützt</p> <p><i>Cartridge heaters sealed with silicone are temperature resistant up to 180°C and should be used in connection with silicone insulated leads.</i> <i>Advantage:</i> moisture protected</p>
	<p>Abb. 0-10: Epoxy</p> <p>Mit Epoxydharz vergossene Heizpatronen sind bis 120°C (optional bis 200°C) temperaturbeständig und können sowohl mit Silikon- als auch PTFE-isolierter Litze verwendet werden. <u>Vorteil:</u> feuchtigkeitsdicht</p> <p><i>Cartridge heaters sealed with epoxy resin are temperature resistant up to 120°C (optional 200°C) and can be used in connection with silicone insulated as well as PTFE insulated leads.</i> <i>Advantage:</i> moisture tight</p>







Schutzleiter

Schutzleiter sind in glasseidenisolierter Reinnickellitze oder PTFE verfügbar und montierbar (auf Anfrage).

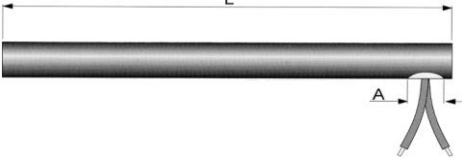
earth lead

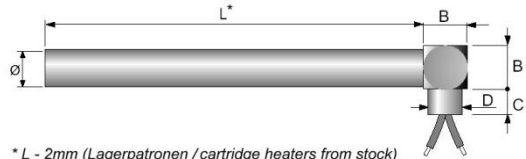
Earth leads are available and mountable in fibre glass insulated nickel leads or PTFE (on request).

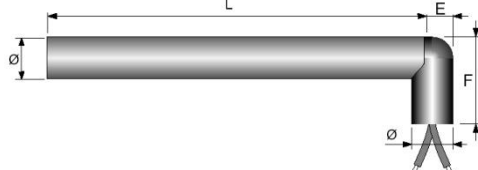
Abgang / termination

Winkelabgang / right angle exit		
<p>Abb. 0-11: Type A</p> 		<p>Abgang der Anschlussleitungen durch den Patronenmantel, mit Keramik vergossen Vorteil: platzsparend, kostengünstig <i>Leads directed through sheath of cartridge heater, sealed with ceramic</i> Advantage: small, cheap</p>
<p>Abb. 0-12: Type B</p>  <p>* L - 2mm (Lagerpatronen / cartridge heaters from stock)</p>		<p>Winkelklotz Vorteil: robust, Schlauchanbringung möglich (s. Schutzschlauch), gasdicht möglich <i>Angle block</i> Advantage: robust, sleeve installation possible (see protection sleeve), gas tight possible</p>
<p>Abb. 0-13: Type C</p> 		<p>Winkelrohrstück Vorteil: platzsparend, Schlauchanbringung möglich (s. Schutzschlauch) <i>Angle tube piece</i> Advantage: small, sleeve installation possible (see protection sleeve)</p>
<p>Abb. 0-14: Type D</p>		<p>Gebogener Abgang Vorteil: gasdicht, Schlauchanbringung möglich (s. Schutzschlauch) <i>Bent termination</i> Advantage: gas tight, sleeve installation possible (see protection sleeve)</p>

Bemaßungstabelle / dimension table:

Ø [mm / "']	4,0 nur Typ C only type C	5,0 nur Typ C only type C	6,5 1/4"	8	10 3/8"	12,5 1/2"	16 5/8"	20 3/4"
A [mm]	-	-	5	5,5	6,5	9,5	12	14
B [mm]	-	-	8	10	12	14	18	22
C [mm]	-	-	6	7	7	8	10	10
D [mm]	-	-	8	10	10	12,5	16	16
E [mm]	2,5	3,2	4,2	5,2	6,5	8	10,5	13
F [mm]	12	14	16	18	22	26	30	36

Einschraubnippel / hexagon head

Abb. 0-15

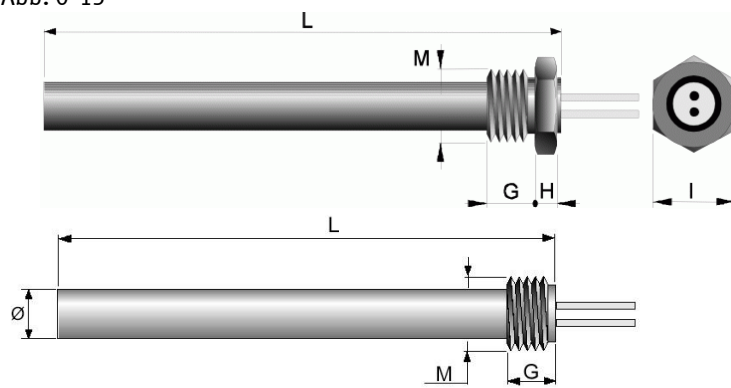

Ø	4,0 mm	5,0 mm	6,5 mm 1/4"	8 mm	10 mm 3/8"	12,5 mm 1/2"	16 mm 5/8"	20 mm 3/4"
Gewinde / thread	-	-	M10 x 1 1/8" Gas	M12 x 1,5	M14 x 1,5 1/4" Gas	M16 x 1,5 3/8" Gas	M20 x 1,5 1/2" Gas	M27 x 1,5 3/4" Gas
G [mm]	-	-	7	9	9	10,5	13	13,5
H [mm]	-	-	3,5	4	4	4,5	5	6,5
I [mm]	-	-	12	14	17	19	24	30

Flansch lang / flange long

Abb. 0-16

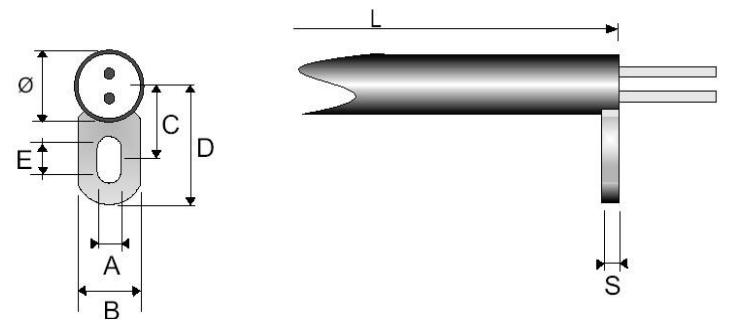

Ø	4,0 mm	5,0 mm	6,5 mm 1/4"	8 mm	10 mm 3/8"	12,5 mm 1/2"	16 mm 5/8"	20 mm 3/4"
A [mm]	-	-	3,2	3,5	3,5	4,5	5,5	6,5
B [mm]	-	-	6	7	9	10	13	15
C [mm]	-	-	8,5	9,5	10,5	13,5	16,5	19,5
D [mm]	-	-	13	14,5	16,5	20,5	25,5	29,5
E [mm]	-	-	3	3	3	4	5	6
S [mm]	-	-	1,2	1,2	1,5	1,5	2	2

Flansch rund / flange round

Abb. 0-17b

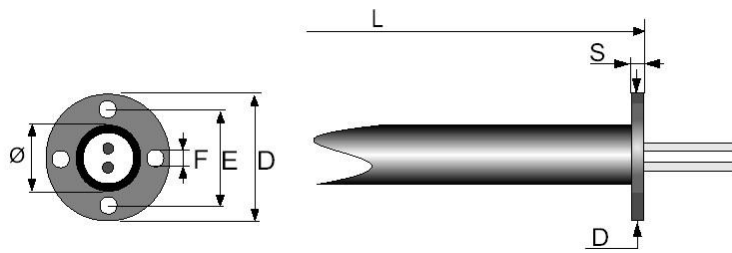

Ø	4,0 mm	5,0 mm	6,5 mm 1/4"	8 mm	10 mm 3/8"	12,5 mm 1/2"	16 mm 5/8"	20 mm 3/4"
D [mm]	-	-	20	20	25	25	33	33
E [mm]	-	-	14	14	19	19	27	27
F [mm]	-	-	3,2	3,2	3,2	3,2	3,2	3,2
S [mm]	-	-	1,2	1,2	1,5	1,5	2	2

Sicherungsring / stop ring

Abb. 0-18c

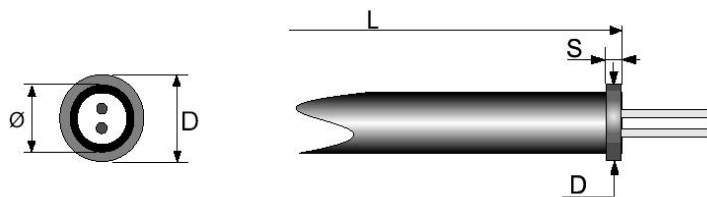

Ø	4,0 mm	5,0 mm	6,5 mm 1/4"	8 mm	10 mm 3/8"	12,5 mm 1/2"	16 mm 5/8"	20 mm 3/4"
D [mm]	-	-	10	12	15	17,5	22	26
S [mm]	-	-	1,2	1,2	1,5	1,5	2	2

Zapfen / extraction nib

Abb. 0-19d

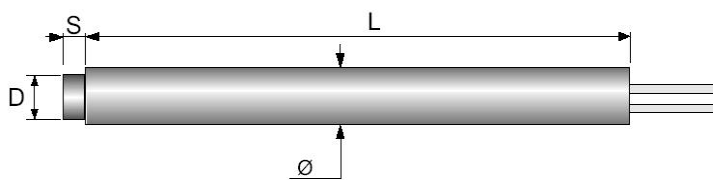

Ø	4,0 mm	5,0 mm	6,5 mm 1/4"	8 mm	10 mm 3/8"	12,5 mm 1/2"	16 mm 5/8"	20 mm 3/4"
D [mm]	-	-	-	-	7,5	9	12	16
S [mm]	-	-	-	-	4	5	6	8

Edelstahlschraube / stainless steel screw

Abb. 0-20e

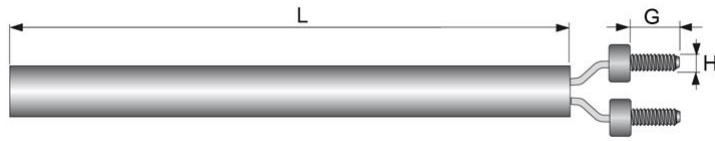

Ø	4,0 mm	5,0 mm	6,5 mm 1/4"	8 mm	10 mm 3/8"	12,5 mm 1/2"	16 mm 5/8"	20 mm 3/4"
H [mm]	-	-	-	-	-	M3	M4	M4
G [mm]	-	-	-	-	-	8	10	10

Edelstahlflachstecker / stainless steel blade terminal

Abb. 0-21f



Ø	4,0 mm	5,0 mm	6,5 mm 1/4"	8 mm	10 mm 3/8"	12,5 mm 1/2"	16 mm 5/8"	20 mm 3/4"
H [mm]	-	-	-	-	-	6,3	6,3	6,3
G [mm]	-	-	-	-	-	8	8	8
S [mm]	-	-	-	-	-	0,8	0,8	0,8

Schutzschlauch / protection sleeve

Silikon imprägnierter Glasseidenschlauch (GLS) / silicone impregnated fibre glass sleeve

- bis 180°C temperaturbeständig
- bis Ø 8mm mit Keramikzement im Kopf eingegossen
- ab Ø 10 mm / 3/8" mit Rohrstück
- Vorteil: flexibel, preisgünstig
- Temperature resistant up to 180°C
- up to Ø 8 mm cast with ceramic cement in the head
- from Ø 10 mm / 3/8" on with connection tube
- Advantage: flexible, well-priced

Abb. 0-22

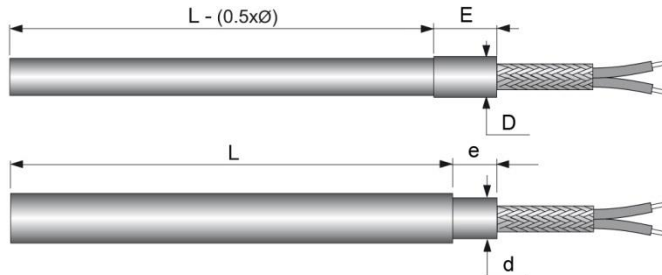

Rohrstück / connection tube

Ø Patrone Ø cartridge	4,0 mm	5,0 mm	6,5 mm 1/4"	8 mm	10 mm 3/8"	12,5 mm 1/2"	16 mm 5/8"	20 mm 3/4"
D [mm]	-	-	-	-	11	-	-	-
E [mm]	-	-	-	-	15	-	-	-
d [mm]	-	-	-	-	-	10,5	14	18 (20 mm) 17 (3/4")
e [mm]	-	-	-	-	-	12	16	20

Silikonkabel / silicone cable

- Bis 180°C temperaturbeständig
- Vorteil: flexibel, mechanisch belastbar und feuchtigkeitsgeschützt in Verbindung mit Silikonverguss
- Temperature resistant up to 180°C
- Advantage: flexible, robust, moisture protected due to silicone seal

Abb. 0-23

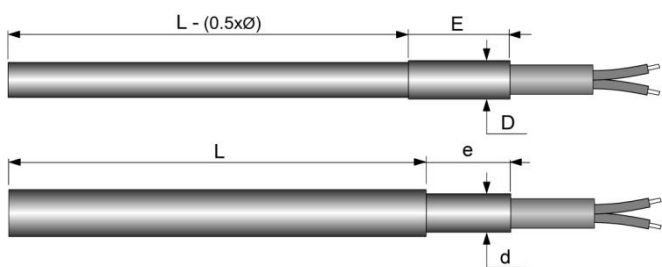

Rohrstück / connection tube

Ø Patrone Ø cartridge	4,0 mm	5,0 mm	6,5 mm 1/4"	8 mm	10 mm 3/8"	12,5 mm 1/2"	16 mm 5/8"	20 mm 3/4"
D [mm]	-	-	7,5	9,2	11	14	-	-
E [mm]	-	-	30	30	35	35	-	-
d [mm]	-	-	-	-	-	10,5	14	18 (20 mm) 17 (3/4")
e [mm]	-	-	-	-	-	30	35	40

Drahtgeflechschlauch (DHG) / braided metal sleeve

- Befestigung mit Rohrstück
- Vorteil: flexibel, mechanisch belastbar

- Fixed with connection tube
- Advantage: flexible, robust

Abb. 0-24

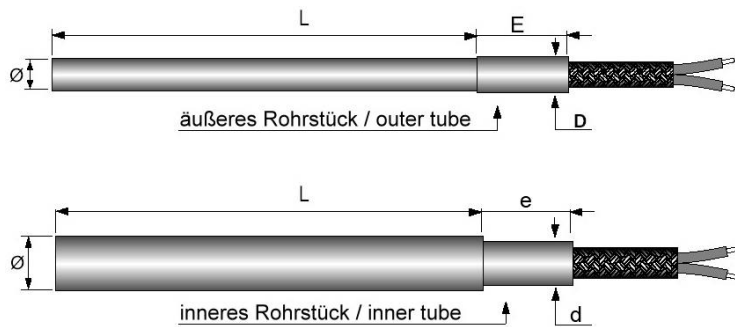

Rohrstück / connection tube

Ø Patrone Ø cartridge	4,0 mm	5,0 mm	6,5 mm 1/4"	8 mm	10 mm 3/8"	12,5 mm 1/2"	16 mm 5/8"	20 mm 3/4"
D [mm]	-	-	7,5	9,2	11	14	-	-
E [mm]	-	-	30	30	35	35	-	-
d [mm]	-	-	-	-	-	-	14	18 (20 mm) 17 (3/4")
e [mm]	-	-	-	-	-	-	35	40

Metallglieberschlauch (MGS) / flexible metal conduit

- Vorteil: mechanisch belastbar

- Advantage: robust

Abb. 0-25: Metallglieberschlauch / Flexible metal conduit

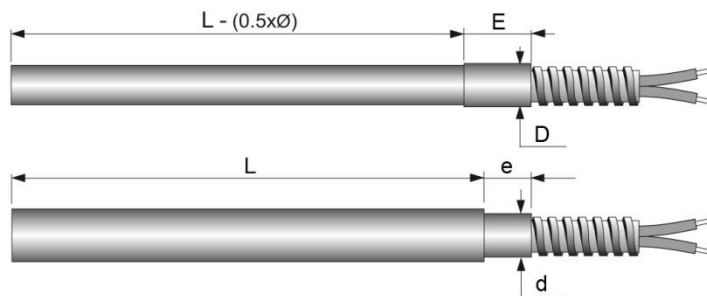

Rohrstück / connection tube

Ø Patrone Ø cartridge	4,0 mm	5,0 mm	6,5 mm 1/4"	8 mm	10 mm 3/8"	12,5 mm 1/2"	16 mm 5/8"	20 mm 3/4"
D [mm]	-	-	7,5	9,2	11	14*	-	-
E [mm]	-	-	10	12	15	16*	-	-
d [mm]	-	-	-	-	-	10,5	14	18 (20 mm) 17 (3/4")
e [mm]	-	-	-	-	-	12	16	20

* bei Hochtemperaturlitze oder > 10 A

* for high temperature leads or > 10 A

Edelstahlwellschlauch (EWS) / stainless steel sleeve

- Vorteil: mechanisch belastbar und gasdicht
- Advantage: robust, gas tight

Abb. 0-26

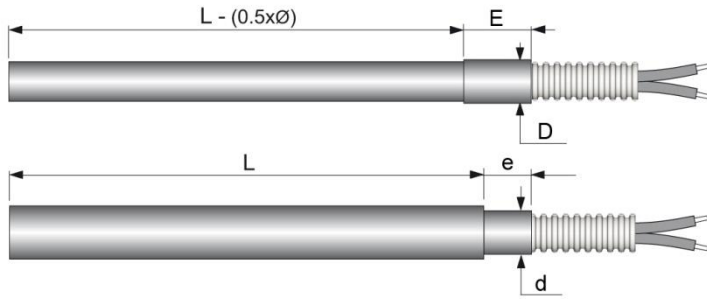

Rohrstück / connection tube

Ø Patrone Ø cartridge	4,0 mm	5,0 mm	6,5 mm 1/4"	8 mm	10 mm 3/8"	12,5 mm 1/2"	16 mm 5/8"	20 mm 3/4"
D [mm]	-	-	-	-	11	14	-	-
E [mm]	-	-	-	-	15	16	-	-
d [mm]	-	-	-	-	-	-	14	18 (20 mm) 17 (3/4")-
e [mm]	-	-	-	-	-	-	16	20

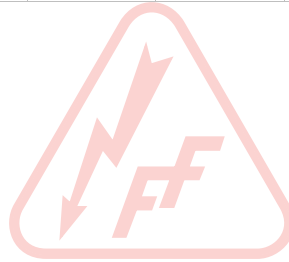

Leistungsverteilung / differential power

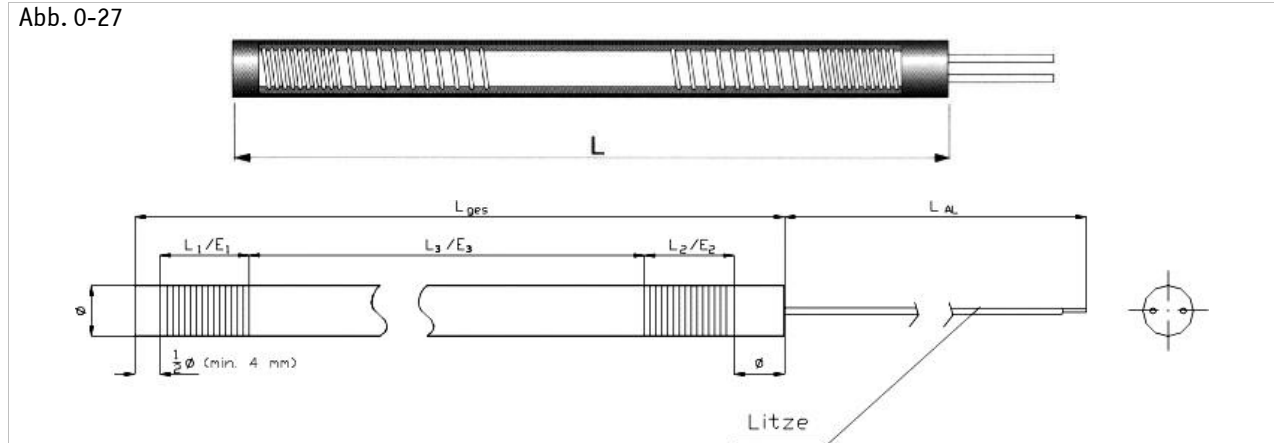

In der Regel kann die über die Patronenlänge erzeugte elektrische Wärmeenergie nicht gleichermaßen „gut“ abfließen. Das führt zu inhomogenen Temperaturverläufen entlang des Patronenmantels („Wärmebauch-Phänomen“). Wo dies vermieden werden soll, können Heizpatronen mit Leistungsverteilung Abhilfe schaffen. Dazu wird an beiden Enden auf einer bestimmten Länge (L_1 und L_2) der Heizleiter dichter gewickelt, wodurch sich in diesen Bereichen eine relative Leistungserhöhung ergibt (Leistungsanteile E_1 und E_2 in %, $E_1+E_2+E_3 = 100\%$).

The cartridge heater can usually not emit heat homogenously over its length. For applications in which this is to be avoided, cartridge heaters with heat distribution can be used. For that purpose the heating wire is coiled denser on a specific length (L_1 and L_2) at both ends. This leads to a relative power increase in these areas (power shares E_1 and E_2 in %, $E_1+E_2+E_3 = 100\%$).

1.3 Verdichtete Heizpatronen
Medium-Density Cartridge Heaters

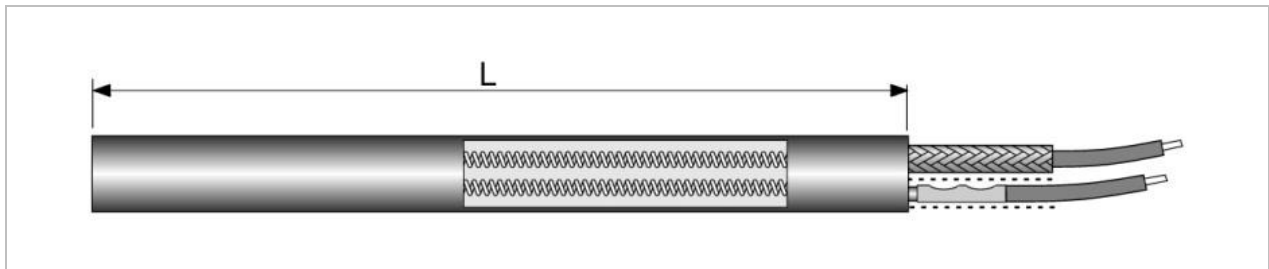

Verdichtete Heizpatronen erzeugen ihre Wärmeenergie mit einer durch Lochkeramiken geführten Heizleiterwendel. Sie eignen sich besonders für Anwendungsfälle, in denen keine hohe Oberflächenbelastung oder sehr lange Heizpatronen verlangt werden.

Medium-density cartridge heaters produce their energy with a heating coil which is lead through hole ceramics. They are specially suitable for applications where no high surface watt density is needed or very long cartridge heaters are required.

Standard-Anschluss: 250 mm glasseidenisolierte Reinnickellitze, außen angeschlagen (Typ N)

Standard leads: 250 mm fibre glass insulated nickel lead, externally connected (type N)

Auf Wunsch können die Patronen mit einer geschliffenen Oberfläche für eine Bohrung mit H7 Toleranzfeld versehen werden (bei den Hochleistungsheizpatronen Standard).

If required we can produce the cartridges with a ground surface for a drill hole with H7 tolerance zone which is standard only for high-density cartridge heaters.

Ø [mm / "']	6,5 1/4"	8	10 3/8"	12,5 1/2"	16 5/8"	20 3/4"
min L [mm]	160	160	200	300	400	500
max L [mm]	1000	1000	1400	1800	2000	2000
max Ampère	4	5	7	10	14	18
max Watt/cm ²	15	15	15	14	14	13
max Volt	240	240	240	240	400	400
max Watt (240V)	900	1000	1400	2000	3400	4500
max Watt (400V)	-	-	-	-	5000	7000

Technische Daten und Toleranzen:
(Aus dieser Tabelle können keine Garantieansprüche abgeleitet werden)

Leistung:	+10%	-10%
Widerstand:	+10%	-10%
Hochspannungsfestigkeit:	1500 V	
Isolationswiderstand (bei 500 V DC):	> 10 MΩ	
Ableitstrom (kalt):	< 0,5 mA	
Max. Arbeitstemperatur:	500 °C	
Längentoleranz:	±2 %	

Technical data and tolerances:
(No warranty claims can be derived from this table)

Wattage:	+10%	-10%
Resistance:	+10%	-10%
Dielectric strength (voltage applied):	1500 V	
Insulation (cold 500 V DC):	> 10 MΩ	
Leakage current (cold):	< 0,5 mA	
Max. working temperature allowed on sheath:	500 °C	
Length tolerance:	±2 %	



1.4 Kleinspannungsheizpatronen
Low Voltage Cartridge Heaters

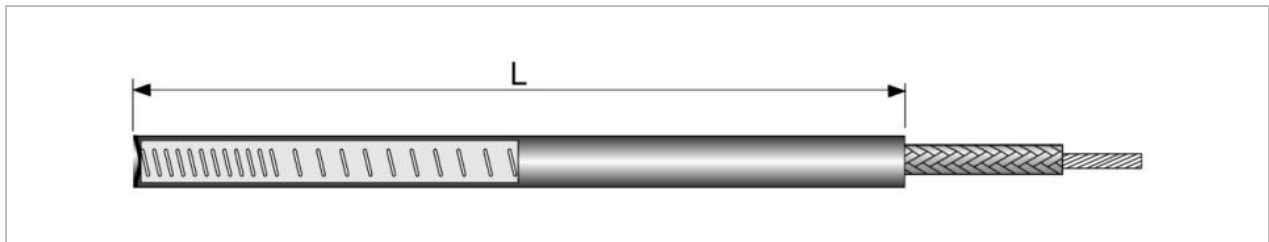

Kleinspannungsheizpatronen sind unipolare Heizpatronen, bei denen die Heizleiterwendel (NiCr 80/20), eingebettet in hochverdichtetem MgO, koaxial im Patronenmantel liegt. Zur einen Seite sind sie verbunden mit der Anschlusslitze und zur anderen mit dem Patronenboden.

Low-voltage cartridge heaters are unipolar elements in which the heating coil (NiCr 80/20) lies embedded in high compacted MgO co-axial to the sheath. On one side it is connected with the lead, on the other side with the bottom disc.

Standard-Anschluss: 500 mm glasseidenisolierte Reinnickellitze

Standard leads: 500 mm fibre glass insulated nickel leads

Standardpatronen / standard sizes

Ø mm	L mm	W 24 V	W/cm ²
4,5	40	60	15
		100	25
-0,02	50	60	11
		100	18
-0,04	60	80	11
		125	17
	70	80	10
		125	15
	80	100	11
		160	17
	100	100	8
		160	13
	130	125	7
		200	12

V_{min} = 6 V

V_{max} = 48 V

Größere Durchmesser und / oder Gewindestift auf Anfrage
Larger diameters and / or threaded pin on request

1.5 Quadratische Heizpatronen
Square Cartridge Heaters

Webcode
105

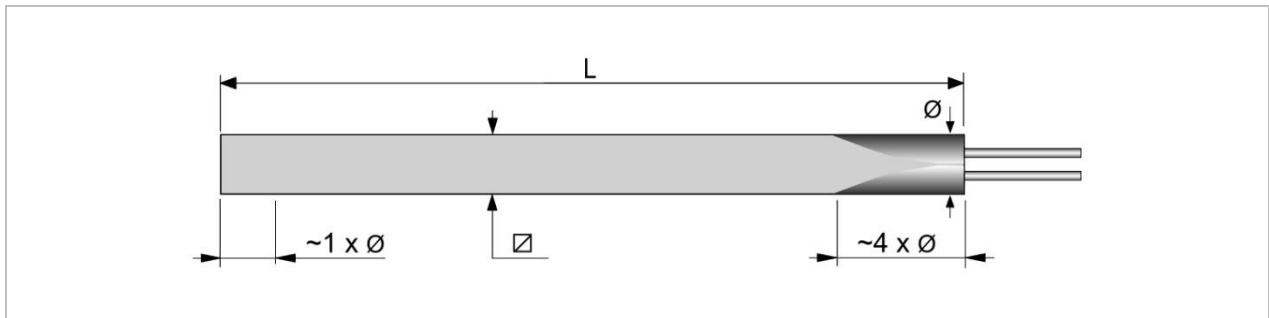

Quadratische Heizpatronen haben ihren Einsatzbereich dort, wo eine hohe Heizleistung nah an der Werkzeugoberfläche installiert werden muss, so z.B. in Schnittmessern, Siegelstationen oder Heizplatten. Am einfachsten gelingt dies durch Einpressen der Heizpatrone in eine Rechtecknut. Neben der vorteilhaften Wärmeabgabe über $\frac{3}{4}$ der Mantelfläche, entfällt zudem das Eingießen bzw. Einzementieren, wie es bei runden Heizungsquerschnitten nötig ist. Im Unterschied zu den ebenfalls quadratisch erhältlichen Rohrheizkörpern (siehe Kapitel 4.1 Flexible Heizschlangen), besitzen quadratische Heizpatronen einen einseitigen Anschluss und können aufgrund ihres inneren Aufbaus mit bis zu 16 W/cm^2 belastet werden.

Square cartridge heaters are used where much power has to be installed near the surface of a tool, e. g. in cutting knives, sealing stations or hot plates. The cartridge heaters can easily be pressed into a rectangular groove. Apart from the advantageous heat transfer over $\frac{3}{4}$ of the sheath, it is not necessary to cement or cast in the heater which is imperative for round cartridge heaters. Unlike tubular heaters which are also available in square sections (see chapter 4.1 Flexible Heating Pipes), the square cartridge heaters have the termination on one side and can be loaded with 16 W/cm^2 (2.5 W/in^2) due to their special inside construction.

Querschnitte / cross sections					
□	$4,5 \times 4,5 \pm 0,1$	$6 \times 6 \pm 0,1$	$8 \times 8 \pm 0,1$	$10 \times 10 \pm 0,15$	$6 \times 12 \pm 0,15$
∅	$4,5 \pm 0,1$	$6 \pm 0,1$	$8 \pm 0,1$	$10 \pm 0,15$	$10 \pm 0,15$

Anschluss / connection

Wie bei zylindrischen Heizpatronen (siehe Kapitel 1.2 Optionen)
Just like round cartridge heaters (see chapter 1.2 Options)

Mantel / sheath

Edelstahl 1.4541 (Nickel 2.4068) / stainless steel 1.4541 (nickel 2.4068)

Biege weiche Ausführungsvarianten / Bendable executions

Zum Anpassen an 2D&3D-Konturen / adjustable to 2D&3D contours

	Mit Anschlusskopf / with terminal head $4,5 \times 4,5 \text{ mm} \rightarrow \text{∅ } 6,5 \times 30 \text{ mm}$ $6,0 \times 6,0 \text{ mm} \rightarrow \text{∅ } 8,0 \times 30 \text{ mm}$ $8,0 \times 8,0 \text{ mm} \rightarrow \text{∅ } 9,2 \times 30 \text{ mm}$ $10 \times 10 \text{ mm} \rightarrow \text{auf Anfrage / on request}$ $6,0 \times 12 \text{ mm} \rightarrow \text{auf Anfrage / on request}$
	Mit Nickel-Anschlussdomen / with nickel pins

1.6 Service Service



Benutzerhinweise

- Durch die hygroskopische Eigenschaft der verwendeten keramischen Isolationswerkstoffe ziehen diese Feuchtigkeit. Deshalb versenden wir unsere Heizpatronen i.d.R. eingeschweißt im luftdicht abgeschlossenen Kunststoffbeutel. Bei ungeschützter Lagerung an Umgebungsluft ist vor Inbetriebnahme unbedingt der Isolationswiderstand festzustellen und ggf. eine Trocknungsphase vorzusehen (Anfahrtschaltung oder Trockenofen). Falls Feuchtigkeit im Heizelement ist und 230 V Spannung angelegt wird ohne vorherige Trocknungsphase, ist ein Ausfall des Heizelementes sehr wahrscheinlich.
- Ein Abbiegen außen liegender Verbindungsstellen (Anschlussausführung Typ N) kann zum Bruch der Anschlüsse führen und ist deshalb unbedingt zu vermeiden. Häufige Bewegungen glasfaserisolierter Anschlussleitungen können zur Beschädigung führen und sind deshalb zu vermeiden.
- Die max. Temperaturbelastung von 750°C am Patronenmantel gilt nicht für den Anschlussbereich. Die im Anschlussbereich auftretenden Temperaturen bestimmen maßgeblich die Eignung zur Auswahl stehender Anschlussausführungen.
- Die max. Temperaturbelastung von 750°C am Patronenmantel impliziert die Annahme eines "normalen" Wärmeabflusses und damit eines "normalen" Temperaturgradienten zum Heizleiterdraht. Einbau- und Betriebsbedingungen mit besonders guter Wärmeleitung (z.B. Wärmetauscheranwendungen auf Aluminiumbasis) erhöhen den Temperaturgradienten z.T. erheblich und damit die Temperatur am Heizleiter. Die max. Temperaturbelastung am Patronenmantel muss in solchen Einsatzfällen entsprechend niedriger angesetzt werden, was insbesondere bei der regeltechnischen Systemauslegung zu beachten ist (Fühlerposition, Regeltemperatur, Hysterese).
- Die angegebene Nennspannung darf nicht überschritten werden, da ansonsten Überhitzungsgefahr besteht.
- Grundsätzlich gilt: je besser die erzeugte Wärme abfließen bzw. in das zu beheizende Werkstück einströmen kann, desto höher kann die Oberflächenbelastung am Patronenmantel gewählt werden.
- Leistungsdichten am Patronenmantel von bis zu 50 W/cm² sind nur geregelt und bei thermisch günstigen Einbauverhältnissen vertretbar. Gut Wärme leitende Konstruktionswerkstoffe und ein eng tolerierter Patronensitz werden deshalb unbedingt empfohlen.
- Für unsere geschliffenen Hochleistungsheizpatronen empfehlen wir H7-Bohrungen mit möglichst geringer Rautiefe.
- Bohrungsformfehler, Querbohrungen oder Lunker behindern die Wärmeabfuhr und führen zu Wärmestaus, was zu einem kritischen partiellen Überhitzen der Patrone führen kann.
- Der Anschlussbereich von Heizpatronen muss grundsätzlich geschützt werden vor Schmier-, Reinigungs- und Lösungsmitteln, da diese in die Keramik eindiffundieren und zu Kurzschlüssen führen können.
- Im festen Verbund mit Materialien unterschiedlicher Wärmeausdehnung (z.B. Stahl und Aluminium) oder bei extremen Temperaturgradienten entlang des Patronenmantels können Heizleiter und Anschlussdorne starken Zugbelastungen ausgesetzt werden und im ungünstigsten Falle reißen bzw. brechen. Ursache hierfür sind z.B. das Aufreißen von vor Korrosion schützenden Passivschichten oder das Herabsetzen von Warmzugfestigkeiten durch in bestimmten Temperaturbereichen eintretende Gefügeveränderungen bzw. Phasenumwandlungen. Insbesondere bei hohen Betriebstemperaturen und unvermeidbaren mechanischen Wechselbelastungen sind ausgiebige Belastungs- und Lebensdauertests vor Serienanlauf unabdingbar.
- Da es in jeder Praxisanwendung Betriebs- und Umgebungsparameter gibt, die sich in der Theorie nicht exakt bestimmen lassen, empfehlen wir grundsätzlich, Heizpatronen vorab in der Anwendung selbst unter den tatsächlichen Betriebsbedingungen zu testen.

Aus den Benutzerhinweisen können keine Garantieansprüche abgeleitet werden.

User Manual

- *Because of the hygroscopic characteristic of the used ceramic insulation materials they absorb moisture. Therefore we send our cartridge heaters usually in air-tightly closed plastic bags. When stored unprotected in environmental air it is absolutely important to check the insulation resistance before use and - if necessary - to dry the elements (controlled start-up or drying oven). If humidity is inside the heater and 230 V is applied to it before pre-heating, it is very probable heater failure.*
- *Bending the outside connection points (exit type N) could break the termination and must be avoided. Frequent movements of glassfibre isolated leads may cause damage and therefore has to be avoided.*
- *The temperature stress of max. 750°C at the sheath is not valid for the connection area. The temperatures arising in the connection area determine decisively the suitability of the available exits.*
- *The max. temperature resistance of 750°C at the sheath implies the assumption of a "normal" heat conduction and thus a "normal" temperature gradient to the heating wire. Installation and operation conditions with exceptional superb thermal conduction (e.g. heat exchanger applications using aluminium bodies) increase the temperature gradient considerably and thus result in a higher temperature at the heating wire. Max. temperature at the sheath in such applications must be assessed lower accordingly. This is especially important for the design of the control system (position of thermocouple, control temperature, hysteresis).*
- *The stated nominal voltage must not be exceeded, otherwise overheat is risked.*
- *Generally it can be said: the better heat is carried off, or flows into the work piece respectively, the higher the surface watt density on the sheath can be.*
- *Watt densities on the cartridge sheath of up to 50 W/cm² are acceptable only controlled and in ideal thermal installation conditions. Materials with a good thermal conductivity and a narrow tolerated cartridge heater fit are therefore recommended strongly.*
- *For our ground high density cartridge heaters we recommend H7-holes with a surface roughness as small as possible.*
- *Form errors of the hole, crossing holes or shrinkage cavities obstruct the heat conduction and lead to heat accumulation which could partly overheat the cartridge critically.*
- *The connection area of cartridge heaters must be protected from lubricants, detergents and solvents, because these could diffuse into the ceramic and lead to short-cuts.*
- *In a solid combination of materials with different thermal expansion (e.g. steel and aluminium) or for extreme temperature gradients alongside the sheath of the cartridge heater heating wire and terminal pins can be exposed to heavy tensile loading and if worst comes to worst they can tear resp. break. Cause often is e. g. cracking of corrosion protective passive layers or the reduction of thermal tensile strength due to microstructural changes resp. phase transformation at certain temperature ranges. Especially at high operating temperatures and unavoidable mechanical stress alteration extensive load and endurance tests are indispensable before series start-up.*
- *In every practice application there are working and environmental parameters which can not be calculated exactly in theory. That is why we recommend generally to test cartridge heaters in the application under real working conditions in advance.*

No warranty claims can be derived from this user manual.

Anfrageformular



Spezifikationen:

<input type="checkbox"/>	Durchmesser zylindrische Patrone:	<input type="text"/>	mm	<input type="checkbox"/>	unipolar (Standard 24V)
<input type="checkbox"/>	Querschnitt quadratische Patrone:	<input type="text"/>	mm		
Gesamtlänge:		<input type="text"/>	mm	Spannung:	<input type="text"/>
Menge:		<input type="text"/>	Stück	Leistung:	<input type="text"/>
					W

Optionen:

Thermoelement (s. 8)

<input type="checkbox"/>	Thermofühler Typ J (Fe-CuNi, rot / blau)	<input type="checkbox"/>	Thermofühler Typ K (NiCr-Ni, rot / grün)
--------------------------	------------------------------------------	--------------------------	------------------------------------------

Anschlussausführung (s. 9)

<input type="checkbox"/>	Typ I von innen heraus (Standard für $\varnothing \leq 8\text{mm}$)
<input type="checkbox"/>	Typ N von außen angeschlagen (Standard für $\varnothing > 8\text{mm}$)
<input type="checkbox"/>	Typ F von außen angeschlagen mit Keramikcappe geschützt

Litzenausführung (s. 9)

<input type="checkbox"/>	Glasseidenisierte Litze (Standard 250mm) 300°C	<input type="checkbox"/>	PTFE-isolierte Litze (kein Standard) 260°C
<input type="checkbox"/>	Silikonisierte Litze (kein Standard) 180°C	<input type="checkbox"/>	Hochtemperaturleitung (kein Standard) 500°C

Litzenlänge: mm

Schutzleiter: Ja Nein

Schutzschlauchausführung (s. 14)

<input type="checkbox"/>	Silikon imprägnierter Glasseidenschlauch (GLS)	<input type="checkbox"/>	Drahthohlgeflechtschlauch (DHG)
<input type="checkbox"/>	Edelstahlwellschlauch (EWS)	<input type="checkbox"/>	Metallglierschlauch (MGS)
<input type="checkbox"/>	Silikonkabel		

Länge: mm

Abgangsausführung (s. 10)

<input type="checkbox"/>	Typ A	<input type="checkbox"/>	Typ B	<input type="checkbox"/>	Typ C	<input type="checkbox"/>	Typ D
Sonstiges							

Absenderangaben:

Firma:	<input type="text"/>	Name:	<input type="text"/>
Straße:	<input type="text"/>	Telefon:	<input type="text"/>
PLZ / Ort:	<input type="text"/> / <input type="text"/>	E-Mail:	<input type="text"/>

Telefon: (0 23 73) 95 90 - 0
Telefax: (0 23 73) 95 90 - 30



Inquiry form



Specifications:

Diametre round cartridge heater: mm unipolar (standard 24V)

Cross section square cartridge heater: mm

Total length: mm Voltage: V

Quantity: pieces Wattage: W

Options:

Thermocouple (p. 8)

Thermosensor type J (Fe-CuNi, red / blue) Thermosensor type K (NiCr-Ni, red / green)

Connection Type (p. 9)

Type I internally connected (standard for $\varnothing \leq 8\text{mm}$)

Type N externally connected (standard for $\varnothing > 8\text{mm}$)

Type F contacted in ceramic cap

Leads Type (p. 9)

Fibre glass insulated leads (standard 250mm) 300°C PTFE insulated leads (no standard) 260°C

Silicone insulated leads (no standard) 180°C High temperature leads (no standard) 500°C

Leads length: mm

Earth lead: Yes No

Protection Sleeve (p. 14)

Silicon impregnated fibreglass sleeve Braided metal sleeve

Stainless steel sleeve Flexible metal conduit

Silicone cable

Length: mm

Termination Type (p. 10)

Type A Type B Type C Type D

Miscellaneous

Sender address:

Company: Name:

Street: Telephone:

Zip / Town: / E-Mail:

Telephone: +49 - (0)23 73 - 95 90-0
 Telefax: +49 - (0)23 73 - 95 90-30



