



**kelteks**



[kelteks.com/cargosystem](http://kelteks.com/cargosystem)



**build solid.**

**kelteks**

# Cargo System

MOBILE SHELF FOR  
HEAVY WEIGHT CARGO

**build solid.**



Kelteks d.o.o.  
Dr. Slavka Rozgaja 3  
47000 Karlovac, Croatia - EU

✉ [info@solidian-kelteks.com](mailto:info@solidian-kelteks.com)  
🌐 [www.kelteks.com](http://www.kelteks.com)  
☎ P +385 47 693 300

**30**  
YEARS OF INNOVATION  
EST. 1990



# STANDARD RACK FOR NON-STANDARD CARGO

**kelteks Cargo System** is the solution based on our long-term industry experience. It is suitable for heavy loads and non-standard sizes because of its easily collapsible sidewalls. The heavy-duty construction of the container keeps fragile cargo protected and secured into position during transportation or when stored in warehouse.

**2in1 solution**  
pallet for the transport of goods or stand alone mobile shelf for storing goods.

**makes space**  
3 loaded pallets and 8 disassembled pallets can be stacked on top of each other

**fits perfect**  
16 loaded (open) pallets and 64 disassembled (folded) fit into standard 13m truck.

**ISO standards**  
**kelteks Cargo System** is manufactured according to ISO 1090-1

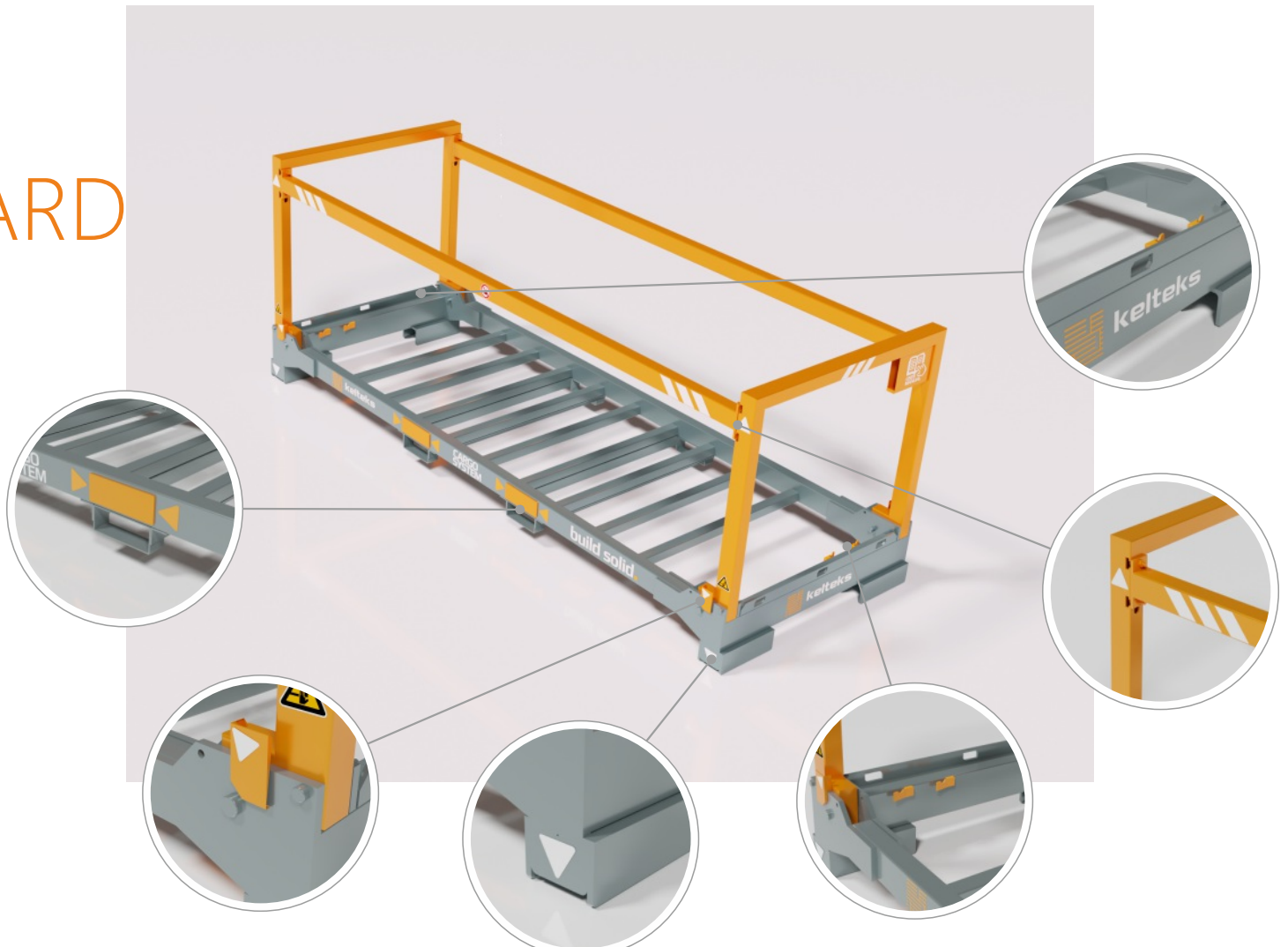

 **Easy Stacking**  
3 loaded pallets or 8 disassembled can be stacked on top of each other.

 **Mobile & modular**  
Use it as a mobile shelf in your warehouse which doesn't have to be fixed to the wall/floor and is easy to manipulate.

 **Easy manipulation**  
Double forklift pockets provide that the pallet can be lifted from all 4 sides and can fit everywhere where you want it to be.

 **Makes Space**  
3x more space in your warehouse by stacking loaded pallets on top of each other. Gives you the space to grow your business.

 **Collapsible walls**  
The perfect solution for oversized loads and sensitive or fragile materials.

 **Load & Secure**  
Security locks and strap holders for extra protection and more options to protect your cargo.

 **GSL system**  
Our Guide Slide Lock system ensures easy manipulation and safe pallet stacking.

 **High Load Capacity**  
Robust steel construction is suitable for heavy loads and provides long service life.

 **Time saving**  
Fast assembly / disassembly and manipulation.

 **Saves resources**  
No wasting of disposable and non-returnable pallets made out of wood or plastic.

 **Non Corrosive**  
Galvanized steel construction for long service life.

 **Hi-Viz**  
Safety first! High visibility reflective labels and markers.

# 4-sided accessibility

Make your job easier and no longer worry about how you will maneuver your pallet because the **kelteks Cargo System** is accessible from all 4 sides. High efficient handling in production, storage, and transportation. Compatible with all (conventional) standard load carriers, forklift trucks, and warehouse systems.

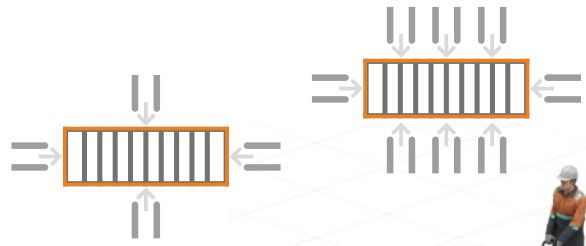

## Stack up! 3 open or 8 closed

You are the owner of your space and you decide how you will use it! **kelteks Cargo System** will never take up extra space if your warehouse is empty. Just assemble it

and place it in your desired position to make room for things that are important to you, like a new machine maybe! Since it is galvanized the pallet will not mind if you leave it outside in the rain or snow.

## TECHNICAL SPECIFICATION

- Net weight: **300kg**
- Max load: **2000kg**
- Max gross weight: **2300kg**
- Superimposed load: **6300kg**
- Height(open): **1240mm**
- Height(folded): **365mm**
- Length: **3350mm**
- Width: **1200mm**
- Cargo space: **4m<sup>2</sup>**
- Loading capacity: **3,2m<sup>3</sup>**
- Load fitting: **3 Euro pallets**

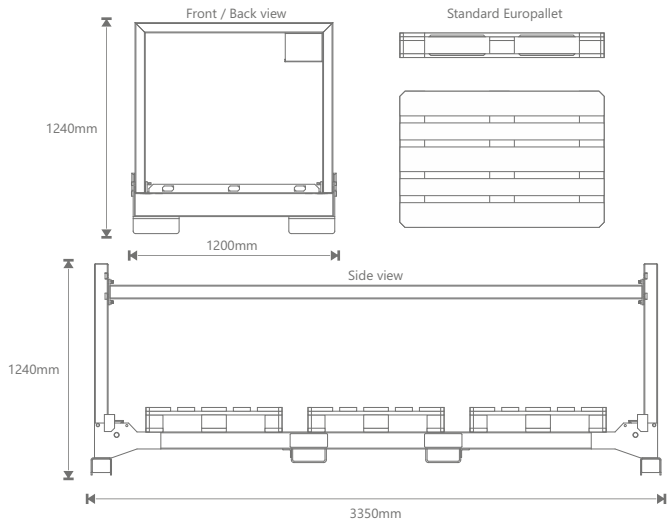

# LOAD MORE in the same space

## Problem:

Do you still have shelves stacked in the shape of streets? Did you fix them to the floors or walls? Your forklifts can move freely, but you have lost a lot of storage space. Admit it, you made a problem for yourself...

## Solution:

...but there is a solution! Mobile, flexible, and not fixed to floors and walls to fill and empty your warehouses instantly. Use the maximum capacity of your warehouse with **kelteks Cargo System**.

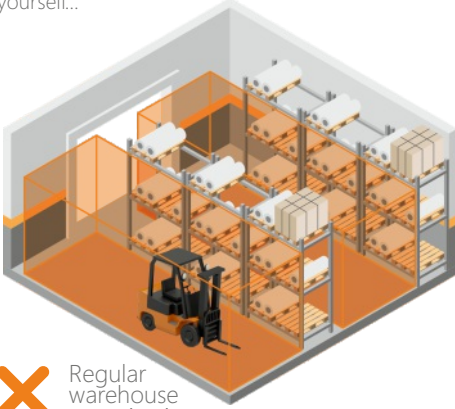

✗ Regular warehouse organization with standard warehouse aisles



Warehouse organized with **kelteks Cargo System** ✓

**+60%** more free space  
We pay for the whole space!  
Why do we only use the floor?

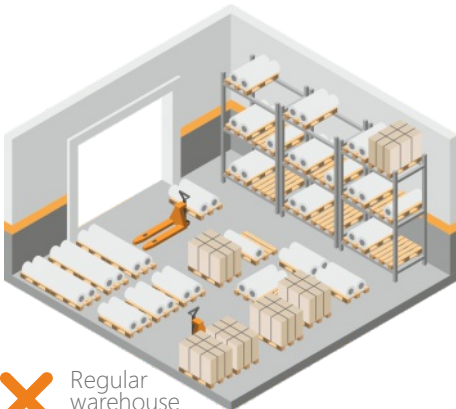

✗ Regular warehouse organization

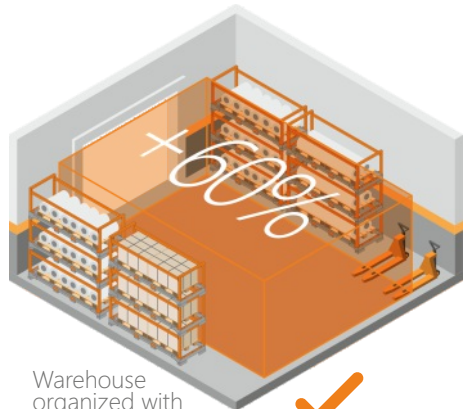

Warehouse organized with **kelteks Cargo System** ✓

OPTIONS  
TO GET YOUR

CARGO SYSTEM

[kelteks.com/cargosystem](http://kelteks.com/cargosystem)

**BUY** option  
for less than **1€/day**

**RENT** option  
for less than **3€/day**

# Optimize Your Supply Chain

**kelteks**  
factory &  
warehouse



fully loaded 16  
**kelteks** Cargo System  
pallets with goods

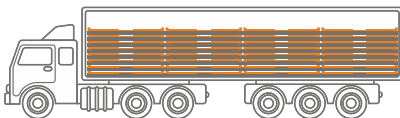
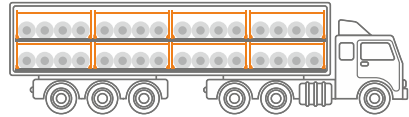

empty & folded 64  
**kelteks** Cargo System



**Your** factory  
& warehouse

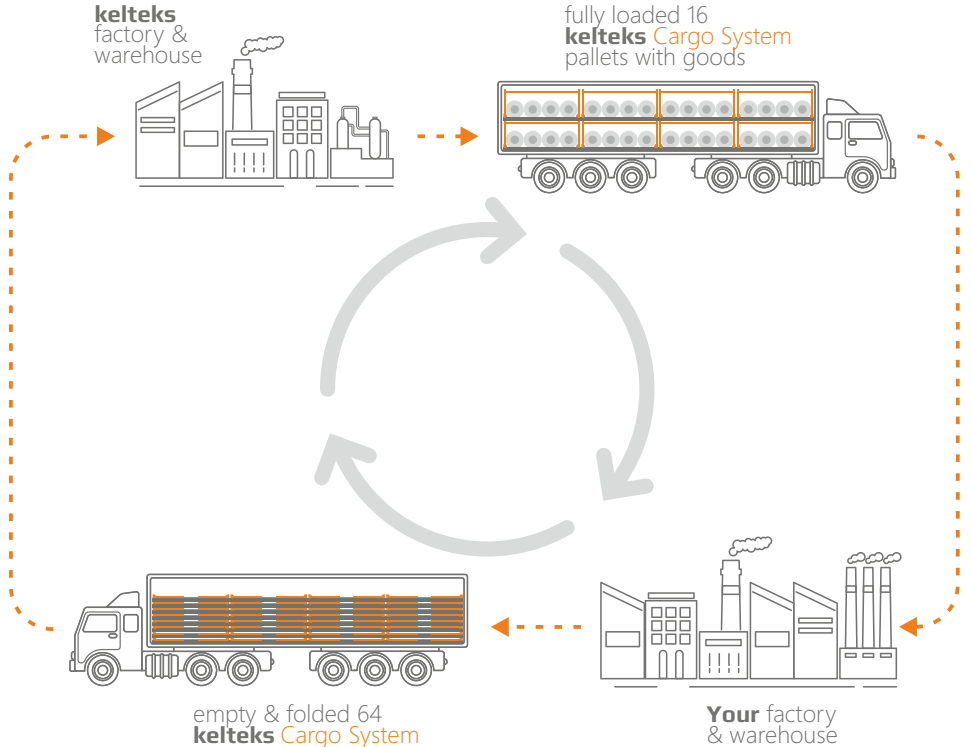

About **keltteks**

Your specialist for technical and functional  
textile development & manufacturing!

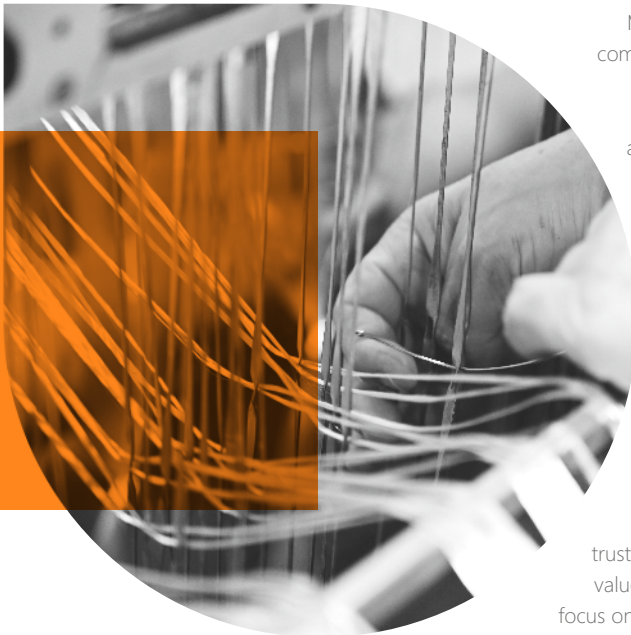
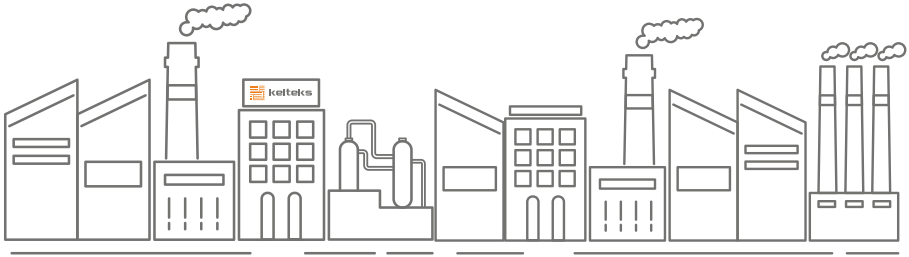

More than 30 years of experience in the composites industry as a manufacturer and developer of high-tech technical textile reinforcements for a large variety of applications. Our field of expertise is the large-scale production, with attention to every detail, of technical fibers such as carbon fibers, glass fibers, basalt fibers, etc., utilizing state of the art machinery and technology.

We are a family owned business and we are proud of the long experience of our 250 well trained, highly educated, and dedicated technical experts that ensure the best products and services for you. You can trust us to be your partner for the complete value chain of your product so that you can focus on your own business. Our 3 factories are located in the heart of Europe in beautiful Croatia, from where we supply our industrial customers in more than 30 countries. It goes without saying that we are certified according to DIN EN ISO 9001:2015 and DIN EN ISO 14001:2015

the  
strongest link  
in your composite

**build solid.**

# Other Products



check out our NEW website for more products and innovative solutions

[kelteks.com/products](http://kelteks.com/products)



**kelteks Edge Protector**

is the NEW solution for the perfect corner reinforcement. Fluffy and cuddly fibers easily squeeze into sharp-edged joints and covers so stress-cracking and laminate chipping is effectively prevented.

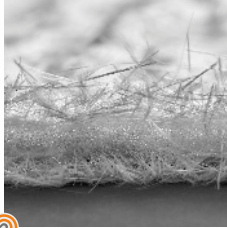

**kelteks FormMat**

consists of 2 layers of chopped fibers and 1 layer of a veil which saves you the time of work and preparation. High-volume fibers allow optimal coverage of critical areas. Especially suitable for the manufacture of parts that require mechanical properties

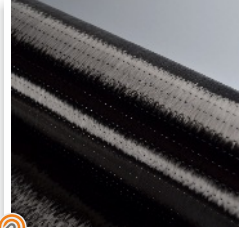

**kelteks Unidirectional**

Unidirectional (UD) fabric is one in which main, long, structural fibers are oriented in one direction, held in place by a secondary non-structural stitching threads. Structural orientation can be in 0 or 90°. Unidirectional fabrics are offering the ability to place fibers in the component exactly where it is required and in the optimum quantity.



**kelteks Woven Roving carbon**

Strength and rigidity qualify carbon fibre reinforced plastics (CFRP) for all areas in which high mechanical loads occur, but the weight should remain low.

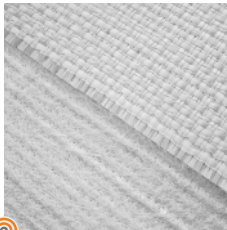

**kelteks Combimat**

We are producing Combimat in many different variations, a combination of fabric with veil (glass, polyester,...), mat (powder or emulsion) or a combination of two fabrics layer. Solutions are unlimited in our production.

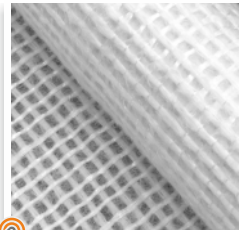

**kelteks Needled Fabrics**

We produce on our own specialized machines that we customized for the production of technical textiles. We are especially proud of the big variety of our specially developed high-performance needles. This, plus our in-house expertise, and highly trained employees can make any needed product for you.

**build solid.**



Kelteks d.o.o.  
Dr. Slavka Rozgaja 3  
47000 Karlovac, Croatia - EU

✉ [info@solidian-kelteks.com](mailto:info@solidian-kelteks.com)  
🌐 [www.kelteks.com](http://www.kelteks.com)  
☎ +385 47 693 300

**30**  
YEARS OF INNOVATIONS  
EST. 1990

