



MANTONI®

THE REUSABLE MASKS
- CATALOGUE -

SIZE OF MASKS:

(MODELS No1-6)

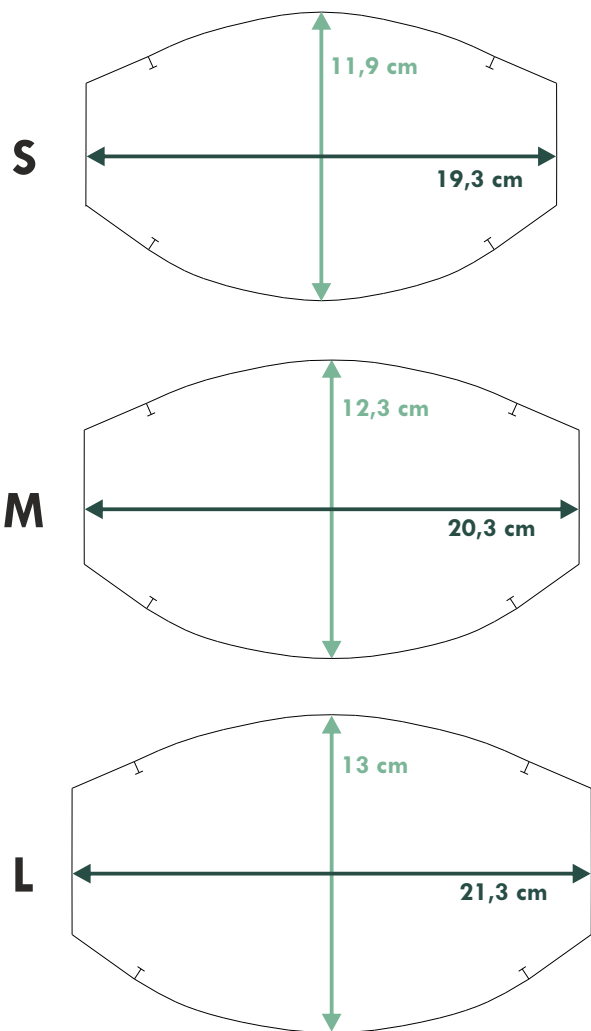

TYPES OF REUSABLE MASKS:

- No1** | 1-Layer with band
- No2** | 2-Layer with band fitted model
- No3** | 2-Layer with band filter pocket
10 pcs. filter included
- No4** | 2-Layer with ties fitted model
filter pocket
10 pcs. filter included
- No5** | 2-Layer with ties **and regulation** fitted model
filter pocket
10 pcs. filter included
- No6** | Mask with sublimation print (any patterns)
- No7** | 3 Laminated Layers **New!** sublimation print **filter FFP2, fitted model** with band or ties
- No8** | 3 Laminated Layers **New!** sublimation print **filter FFP2** with band or ties
- No9** | BUFF
possibility of printing any patterns

EXAMPLES OF COLOURS:



WHITE | GRAY (MELANGE) | VIOLET (MELANGE)
ROYAL BLUE | NAVY | BLACK | MORO



100% COTTON



WITH BAND

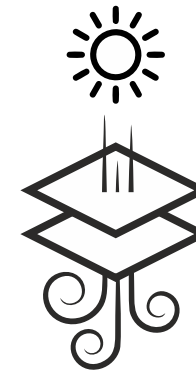

2 - LAYERS
(GOOD FOR WARM
WEATHER -
EASY BREATHING)



FITTED

REUSABLE MASK - MODEL No2

- FABRIC: 100% COTTON (TOP) 100% COTTON (BOTTOM),
SINGLE JERSEY
- FITTED MODEL (WITH CUT)



100% COTTON



WITH BAND

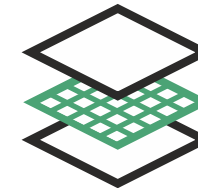

2 - LAYERS
WITH FILTER
POCKET

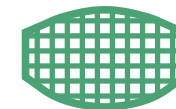

10psc FILTER
REPLACEABLE

REUSABLE MASK - MODEL No3

- FABRIC: 100% COTTON (TOP) 100% COTTON (BOTTOM),
SINGLE JERSEY

- FILTER POCKET + 10 pcs FILTER INCLUDED



100% COTTON



WITH BAND

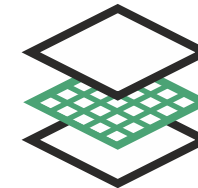

2 - LAYERS
WITH FILTER
POCKET

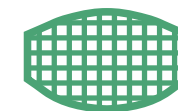

10psc FILTER
REPLACEABLE

REUSABLE MASK - MODEL No3

- FABRIC: 100% COTTON (TOP) 100% COTTON (BOTTOM),
SINGLE JERSEY

- FILTER POCKET + 10 pcs FILTER INCLUDED



100% COTTON



WITH BAND

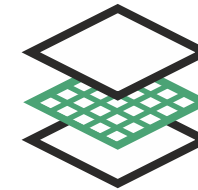

2 - LAYERS
WITH FILTER
POCKET

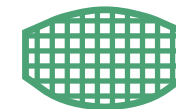

10psc FILTER
REPLACEABLE

REUSABLE MASK - MODEL No3

- FABRIC: 100% COTTON (TOP) 100% COTTON (BOTTOM),
SINGLE JERSEY

- FILTER POCKET + 10 pcs FILTER INCLUDED



100% COTTON



WITH BAND

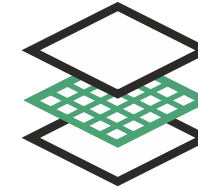

2 - LAYERS
WITH FILTER
POCKET

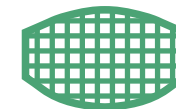

10psc FILTER
REPLACEABLE

REUSABLE MASK - MODEL No3A (THICKER FABRIC)

- FABRIC: 100% COTTON (TOP) 100% COTTON (BOTTOM),
FRENCH TERRY

- FILTER POCKET + 10 pcs FILTER INCLUDED



100% COTTON



WITH TIES

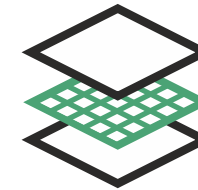

2 - LAYERS
WITH FILTER
POCKET



FITTED

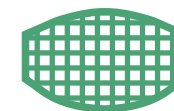

10psc FILTER
REPLACEABLE

REUSABLE MASK - MODEL No4

- FABRIC: 100% COTTON (TOP) 100% COTTON (BOTTOM), SINGLE JERSEY
- FILTER POCKET + 10 pcs FILTER INCLUDED
- FITTED MODEL (NO COUT)



100% COTTON



WITH TIES

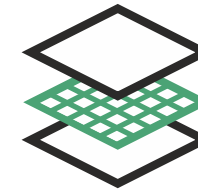

2 - LAYERS
WITH FILTER
POCKET



FITTED

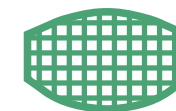

10psc FILTER
REPLACEABLE

REUSABLE MASK - MODEL No4

- FABRIC: 100% COTTON (TOP) 100% COTTON (BOTTOM), SINGLE JERSEY
- FILTER POCKET + 10 pcs FILTER INCLUDED
- FITTED MODEL (NO COUT)

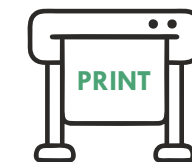

100% POLYESTER
WITH SUBLIMATION
PRINT



WITH BAND

OR

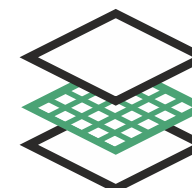

2 - LAYERS
WITH FILTER
POCKET



WITH TIES

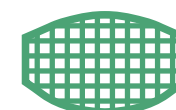

10psc FILTER
REPLACEABLE



100% COTTON
NEAR TO FACE
(COMFORTABLE)

REUSABLE MASK - MODEL No6

- FABRIC: 100% POLYESTER (TOP) 100% COTTON (BOTTOM), FRENCH TERRY
- SUBLIMATION PRINT (POSSIBILITY OF PRINTING ANY PATTERNS)
- FILTER POCKET + 10 pcs FILTER INCLUDED

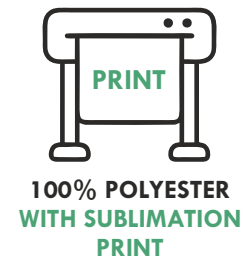
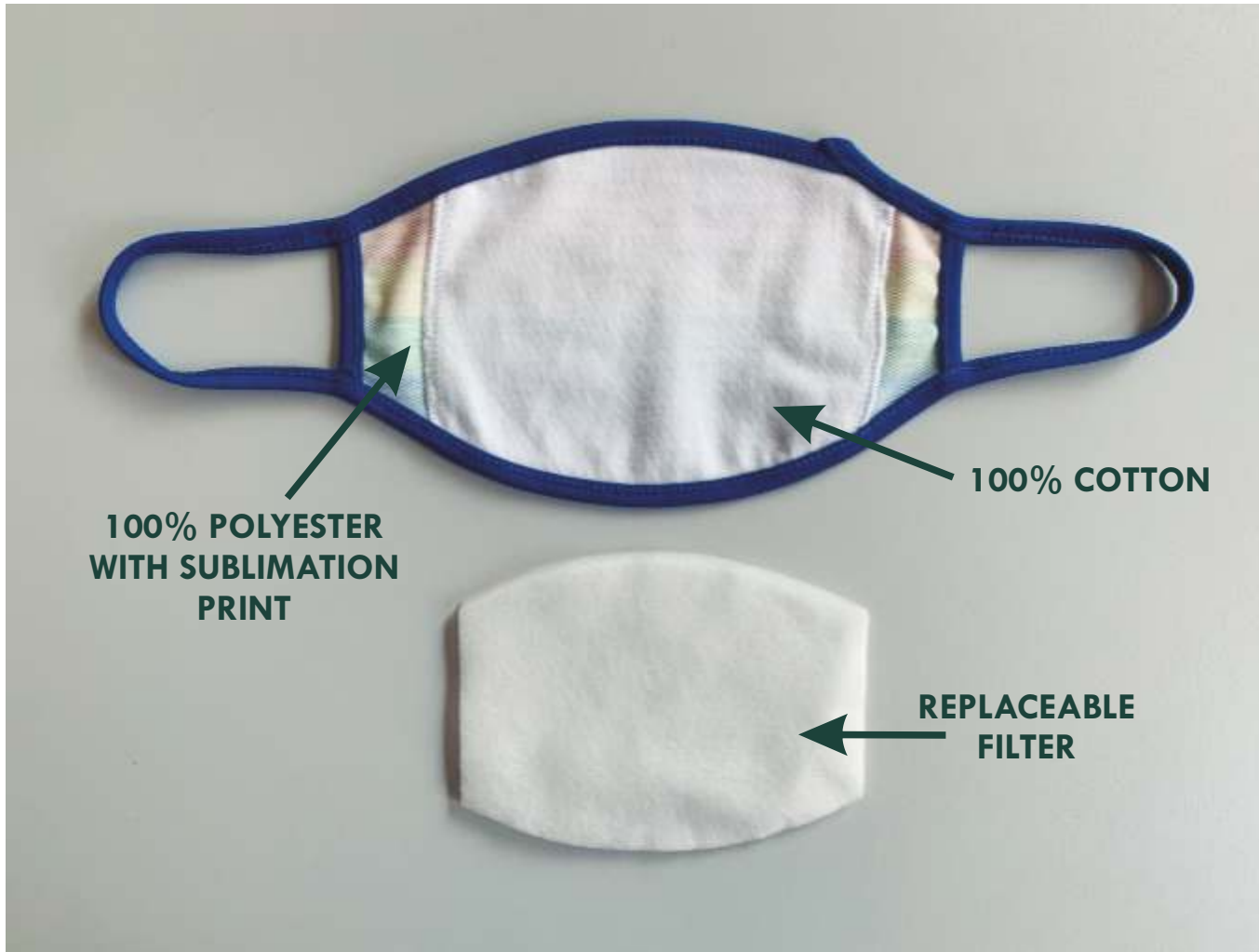

OR

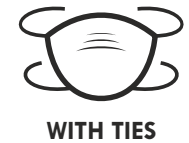
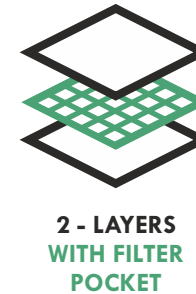

REUSABLE MASK - MODEL No6

- FABRIC: 100% POLYESTER (TOP) 100% COTTON (BOTTOM), FRENCH TERRY
- SUBLIMATION PRINT (POSSIBILITY OF PRINTING ANY PATTERNS)
- FILTER POCKET + 10 pcs FILTER INCLUDED

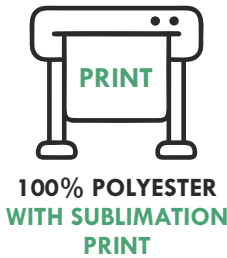
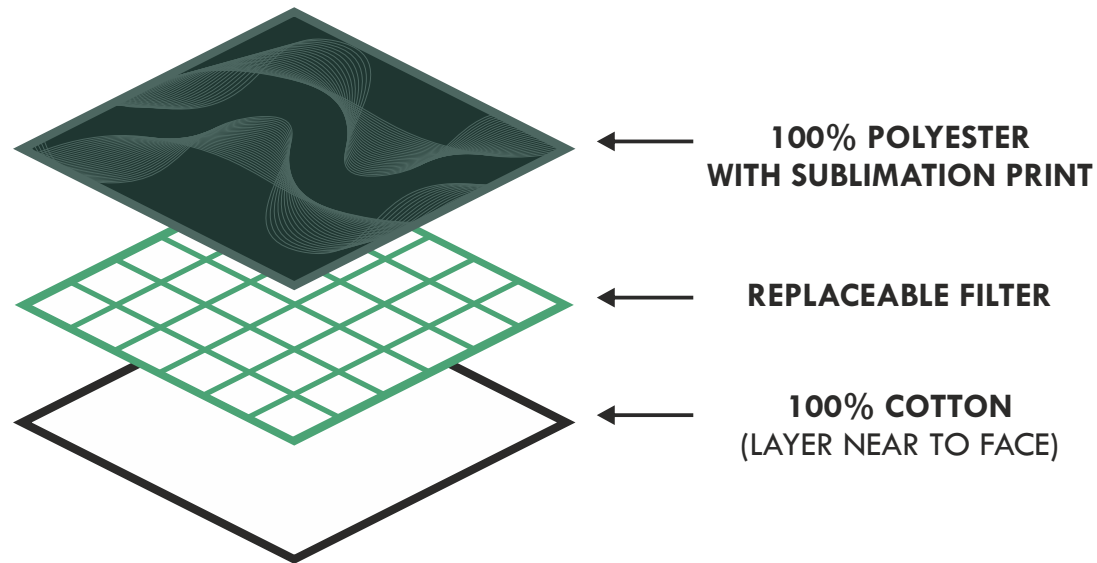

OR

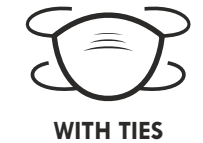
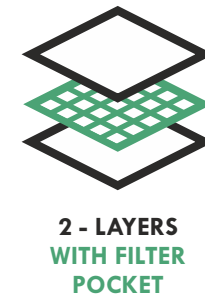



REUSABLE MASK - MODEL No6

- FABRIC: 100% POLYESTER (TOP) 100% COTTON (BOTTOM), FRENCH TERRY
- SUBLIMATION PRINT (POSSIBILITY OF PRINTING ANY PATTERNS)
- FILTER POCKET + 10 pcs FILTER INCLUDED



 **PRINT**
100% POLYESTER
WITH SUBLIMATION
PRINT
AND SILVER PROTECTION
(BACTERIA KILLER)

WITH BAND
OR

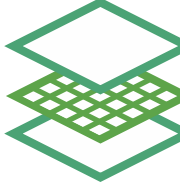
WITH TIES

3 - LAYERS
INTEGRATED
WITH FILTER

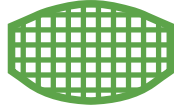

FITTED

FILTER FFP2
96% BACTERIA
AND VIRUS KILLER

100% COTTON
NEAR TO FACE
(COMFORTABLE)

REUSABLE MASK - MODEL No7

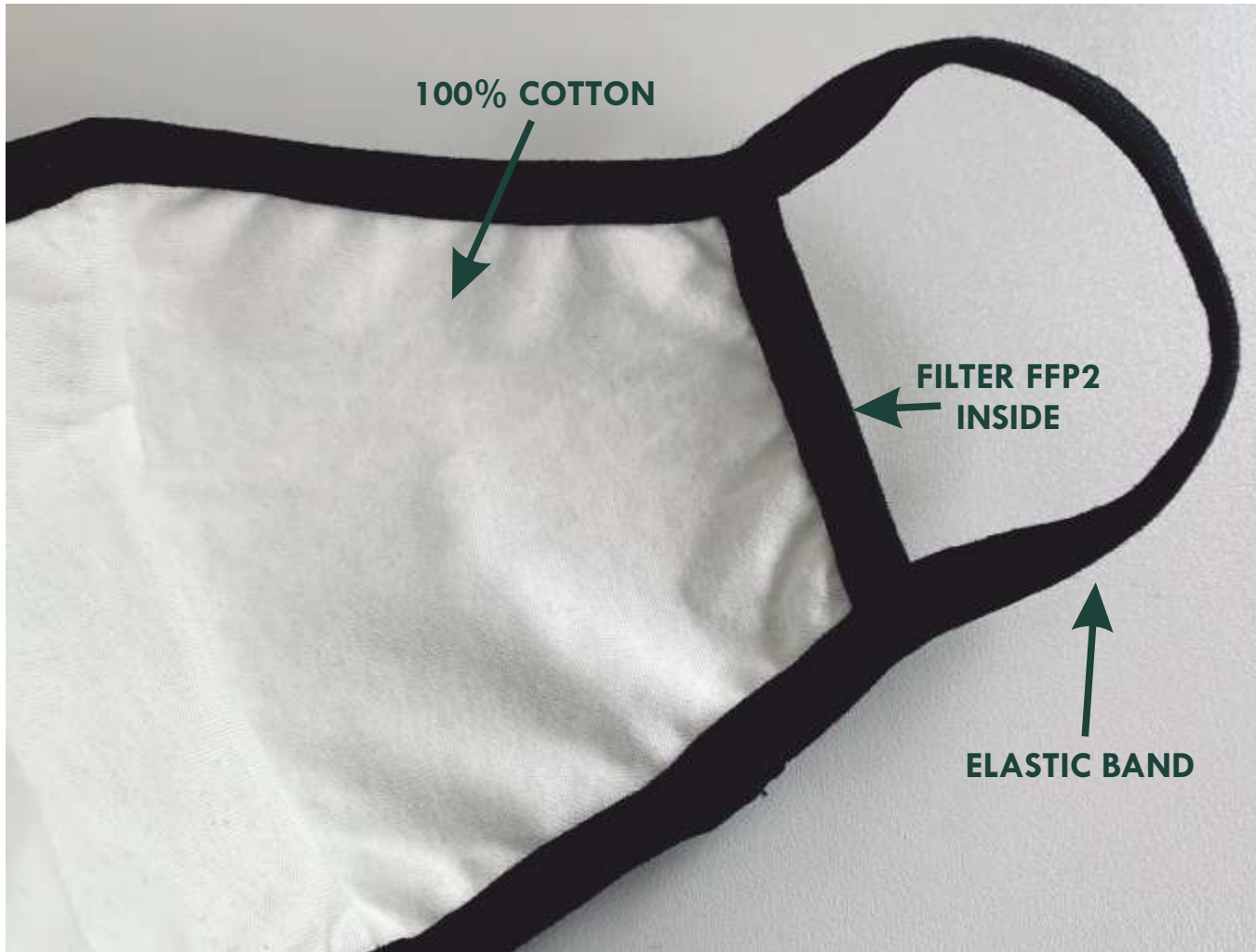
- FABRIC: 100% POLYESTER (TOP), 100% COTTON (BOTTOM)
- LAMINATED WITH **FILTER FFP2** (INSIDE)
- SUBLIMATION PRINT ON TOP LAYER
- (POSSIBILITY OF PRINTING ANY PATTERNS)
- **FITTED** MODEL (WITH CUT)



<p>100% POLYESTER WITH SUBLIMATION PRINT AND SILVER PROTECTION (BACTERIA KILLER)</p>	<p>WITH BAND</p>
	<p>OR</p>
	<p>WITH TIES</p>
<p>3 - LAYERS INTEGRATED WITH FILTER</p>	<p>FITTED</p>
<p>FILTER FFP2 96% BACTERIA AND VIRUS KILLER</p>	<p>100% COTTON NEAR TO FACE (COMFORTABLE)</p>

REUSABLE MASK - MODEL No7

- FABRIC: 100% POLYESTER (TOP), 100% COTTON (BOTTOM)
- LAMINATED WITH **FILTER FFP2** (INSIDE)
- SUBLIMATION PRINT ON TOP LAYER
(POSSIBILITY OF PRINTING ANY PATTERNS)
- **FITTED** MODEL (WITH CUT)

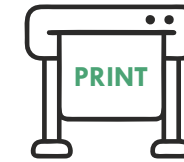

100% POLYESTER
WITH SUBLIMATION
PRINT
AND SILVER PROTECTION
(BACTERIA KILLER)



WITH BAND

OR



WITH TIES

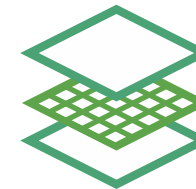

3 - LAYERS
INTEGRATED
WITH FILTER



FITTED

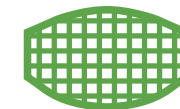

FILTER FFP2
96% BACTERIA
AND VIRUS KILLER



100% COTTON
NEAR TO FACE
(COMFORTABLE)

REUSABLE MASK - MODEL No7

- FABRIC: 100% POLYESTER (TOP), 100% COTTON (BOTTOM)
LAMINATED WITH **FILTER FFP2** (INSIDE)
- SUBLIMATION PRINT ON TOP LAYER
(POSSIBILITY OF PRINTING ANY PATTERNS)
- **FITTED** MODEL (WITH CUT)

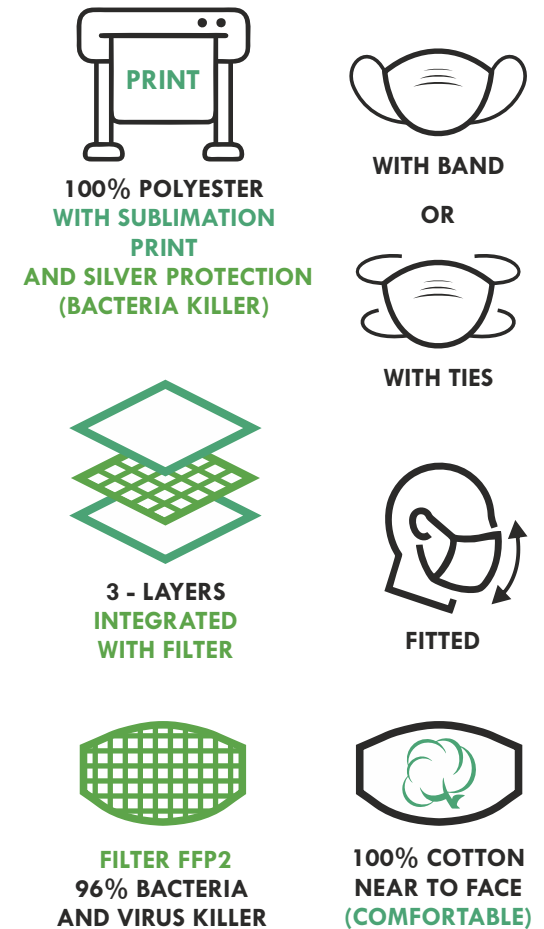
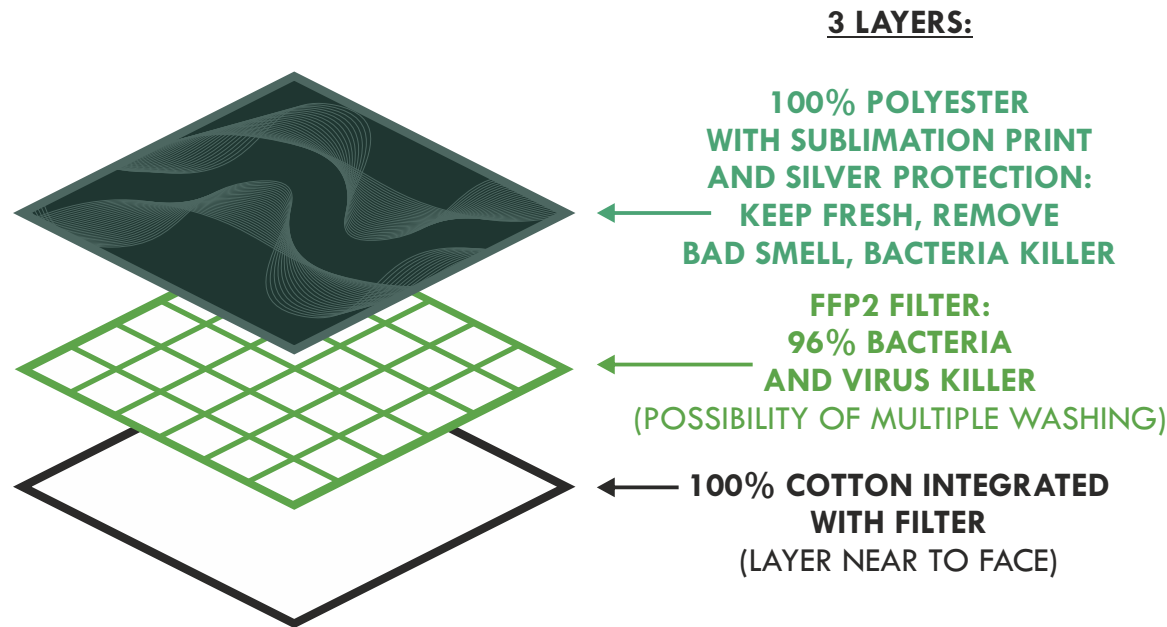

REUSABLE MASK - MODEL No7

- FABRIC: 100% POLYESTER (TOP), 100% COTTON (BOTTOM) LAMINATED WITH **FILTER FFP2** (INSIDE)
- SUBLIMATION PRINT ON TOP LAYER (POSSIBILITY OF PRINTING ANY PATTERNS)
- **FITTED** MODEL (WITH CUT)

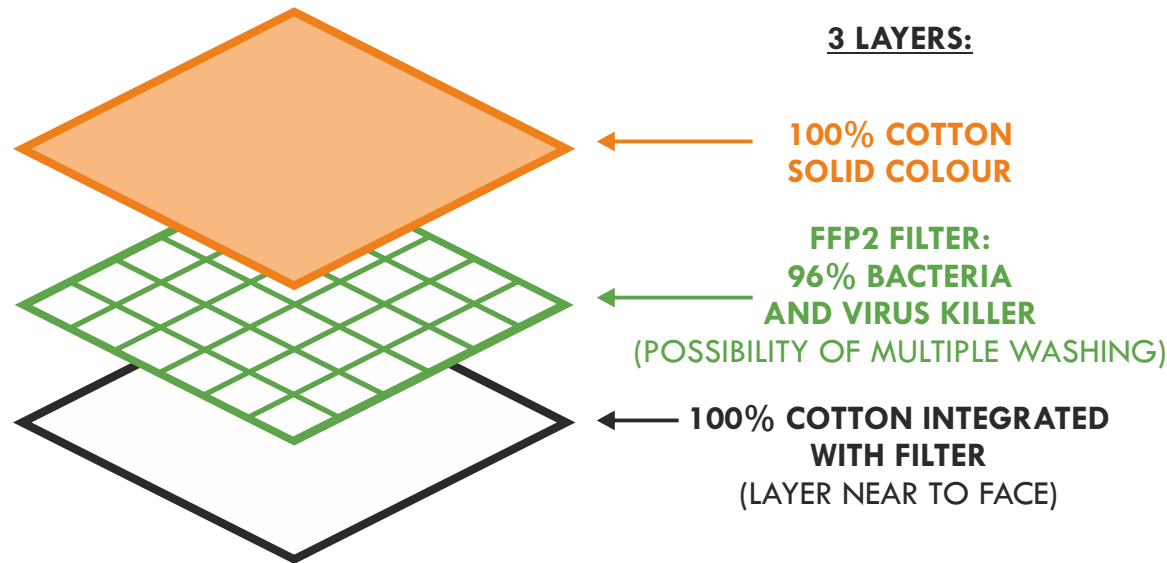

WITH BAND

OR



WITH TIES

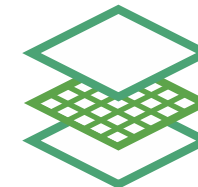

3 - LAYERS
INTEGRATED
WITH FILTER



FITTED

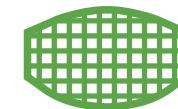

FILTER FFP2
96% BACTERIA
AND VIRUS KILLER



100% COTTON
NEAR TO FACE
(COMFORTABLE)

REUSABLE MASK - MODEL No7A

- FABRIC: 100% POLYESTER (TOP), 100% COTTON (BOTTOM)
LAMINATED WITH **FILTER FFP2** (INSIDE)
- **FITTED** MODEL (WITH CUT)

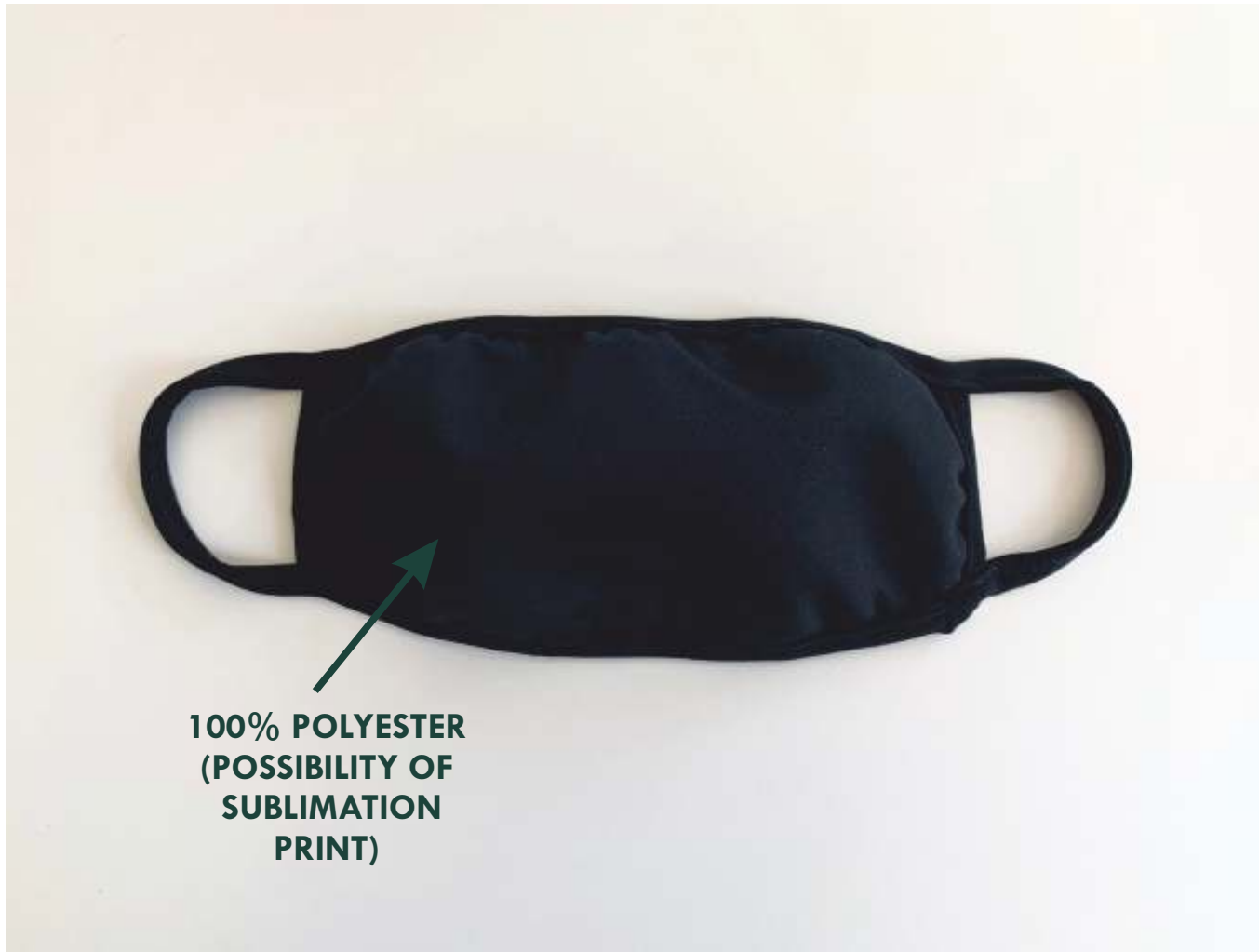

100% POLYESTER
(POSSIBILITY OF
SUBLIMATION
PRINT)



100% POLYESTER
WITH SUBLIMATION
PRINT
AND SILVER PROTECTION
(BACTERIA KILLER)



WITH BAND

OR

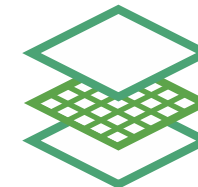

3 - LAYERS
INTEGRATED
WITH FILTER



WITH TIES

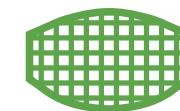

FILTER FFP2
96% BACTERIA
AND VIRUS KILLER



100% COTTON
NEAR TO FACE
(COMFORTABLE)

REUSABLE MASK - MODEL No8

- FABRIC: 100% POLYESTER (TOP), 100% COTTON (BOTTOM)
LAMINATED WITH **FILTER FFP2** (INSIDE)
- SUBLIMATION PRINT ON TOP LAYER
(POSSIBILITY OF PRINTING ANY PATTERNS)



PRINT
100% POLYESTER
WITH SUBLIMATION
PRINT
AND SILVER PROTECTION
(BACTERIA KILLER)



WITH BAND

OR

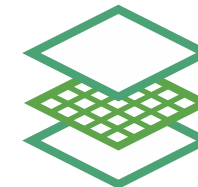

3 - LAYERS
INTEGRATED
WITH FILTER



WITH TIES

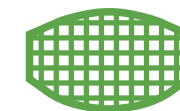

FILTER FFP2
96% BACTERIA
AND VIRUS KILLER



100% COTTON
NEAR TO FACE
(COMFORTABLE)

REUSABLE MASK - MODEL No8

- FABRIC: 100% POLYESTER (TOP), 100% COTTON (BOTTOM)
LAMINATED WITH **FILTER FFP2** (INSIDE)
- SUBLIMATION PRINT ON TOP LAYER
(POSSIBILITY OF PRINTING ANY PATTERNS)

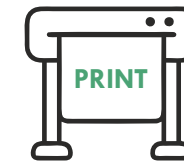

100% POLYESTER
WITH SUBLIMATION
PRINT
AND SILVER PROTECTION
(BACTERIA KILLER)



WITH BAND

OR

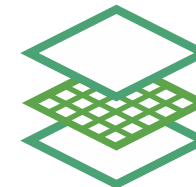

3 - LAYERS
INTEGRATED
WITH FILTER



WITH TIES

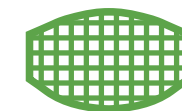

FILTER FFP2
96% BACTERIA
AND VIRUS KILLER



100% COTTON
NEAR TO FACE
(COMFORTABLE)

REUSABLE MASK - MODEL No8

- FABRIC: 100% POLYESTER (TOP), 100% COTTON (BOTTOM)
LAMINATED WITH **FILTER FFP2** (INSIDE)
- SUBLIMATION PRINT ON TOP LAYER
(POSSIBILITY OF PRINTING ANY PATTERNS)

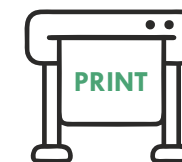

100% POLYESTER
WITH SUBLIMATION
PRINT
AND SILVER PROTECTION
(BACTERIA KILLER)



WITH BAND

OR

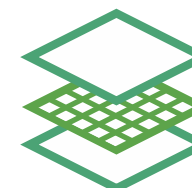

3 - LAYERS
INTEGRATED
WITH FILTER



WITH TIES

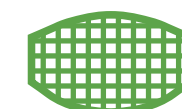

FILTER FFP2
96% BACTERIA
AND VIRUS KILLER



100% COTTON
NEAR TO FACE
(COMFORTABLE)

REUSABLE MASK - MODEL No8

- FABRIC: 100% POLYESTER (TOP), 100% COTTON (BOTTOM)
LAMINATED WITH **FILTER FFP2** (INSIDE)
- SUBLIMATION PRINT ON TOP LAYER
(POSSIBILITY OF PRINTING ANY PATTERNS)

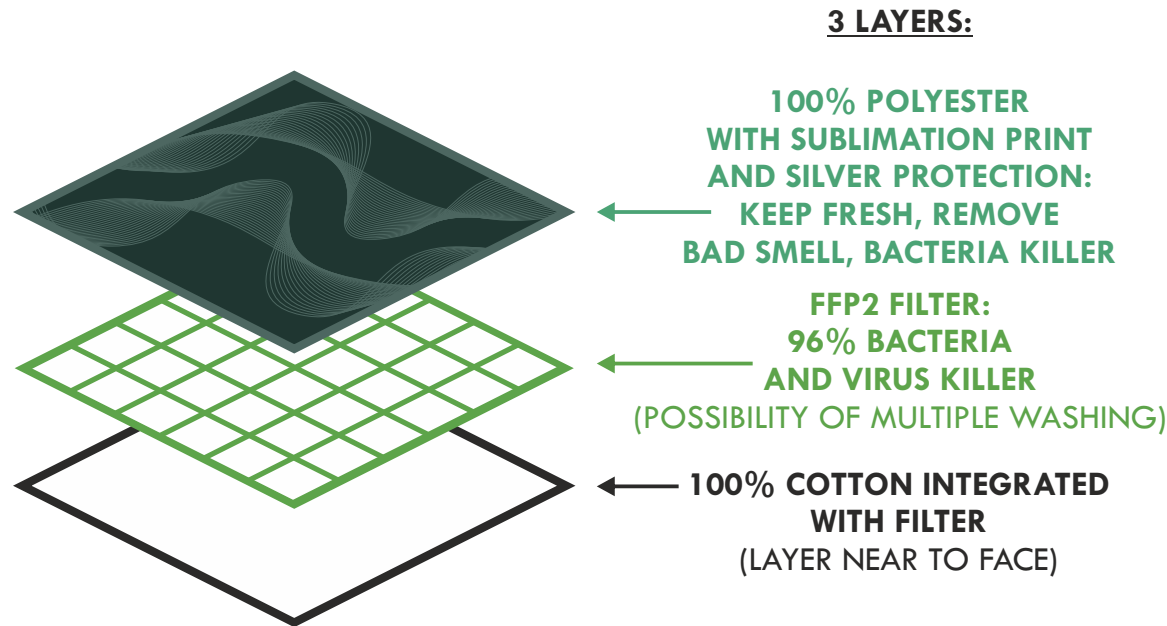

100% POLYESTER WITH SUBLIMATION PRINT AND SILVER PROTECTION (BACTERIA KILLER)



WITH BAND

OR

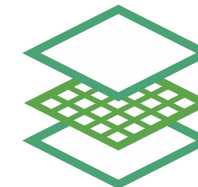

WITH TIES

3 - LAYERS INTEGRATED WITH FILTER

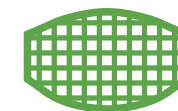

FILTER FFP2 96% BACTERIA AND VIRUS KILLER



100% COTTON NEAR TO FACE (COMFORTABLE)

REUSABLE MASK - MODEL No8

- FABRIC: 100% POLYESTER (TOP), 100% COTTON (BOTTOM) LAMINATED WITH **FILTER FFP2** (INSIDE)
- SUBLIMATION PRINT ON TOP LAYER (POSSIBILITY OF PRINTING ANY PATTERNS)

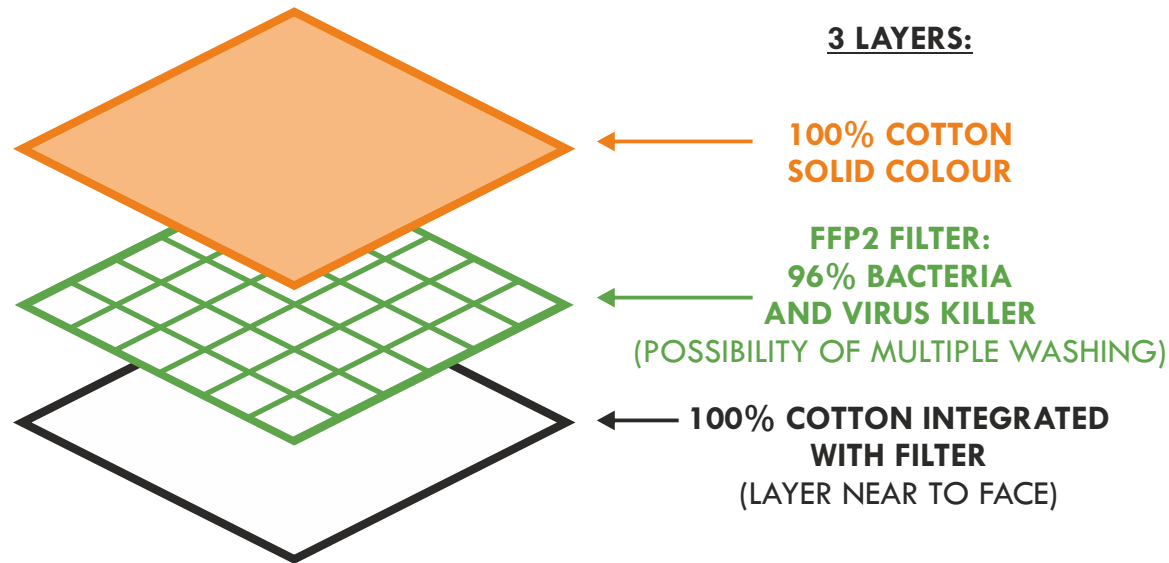

100% COTTON



WITH BAND

OR

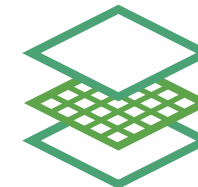

3 - LAYERS
INTEGRATED
WITH FILTER



WITH TIES

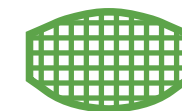

FILTER FFP2
96% BACTERIA
AND VIRUS KILLER



100% COTTON
NEAR TO FACE
(COMFORTABLE)

REUSABLE MASK - MODEL No8A

- FABRIC: 100% POLYESTER (TOP), 100% COTTON (BOTTOM)
LAMINATED WITH FILTER FFP2 (INSIDE)



MANTONI®

+48 606 727 179

biuro@mantoni.pl

www.mantoni.pl

Migdałowa 89

02-796 Warsaw

Poland