

Measuring transducer for frequency, input automotive alternator

- Straightforward application
- Suitable for severe operating conditions
- Compact construction
- Galvanic isolation between sensor input and operating voltage to the output signal
- No additional operating voltage required
- Provision made for fine adjustment of measuring range
- Anti-tamper seal for the fine adjustment
- Meet high EMC-requirements
- **CE** requirements
- Short-circuit-proof output selectable from
0 ... 10 V/DC, 2 ... 10 V/DC, 0 ... 20 mA, 4 ... 20 mA
- Operating characteristics displayed by integrated LED
- Flame-inhibiting and self-extinguishing body

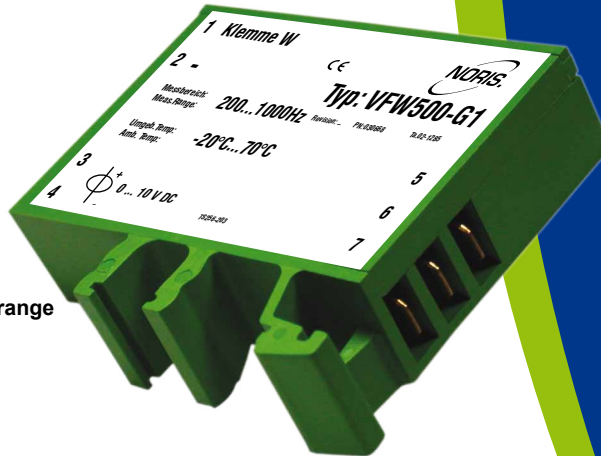

Image
VFW500-G1



Germanischer Lloyd

Measuring transducers of series 5

Measuring transducers of the Series 5 are designed to convert electric input values into standardised output signals.

Principle of operation: The transducer signal measured at the converter input is converted into a standardised output signal that is proportional to the input and lends itself to further customised processing, for instance, in a machine controller.

General notes on Type VFW5..

Description VFW5..

The Type VFW5.. is designed for measuring and transducing a frequency signal of an automotive alternator. The terminal W supplies a pulsating DC-voltage from a coil winding of the alternator with subsequent rectification. There is no signal at standstill. Above a predetermined speed level, a voltage is generated and available as a pulsating DC-voltage of approx. 26 V/DC. Evaluation of this voltage is frequency-oriented. The voltage at the same time provides the operating voltage for the measuring transducer. The frequency range is obtained automatically and there is no need for calibration. The minimum range is the no-load speed of the alternator of approx. 1,500 rpm at approx. 150 Hz. The maximum range is dictated by the maximum speed of the prime mover of approx. 12,000 rpm at approx. 1,200 Hz. Access is provided to a trimming potentiometer for subsequent adjustments of the measuring range. The maximum speed of the prime mover defines 10 V/DC or 20 mA of the output signal. In transforming the signal it is important to take into consideration any step-up/step-down ratios between the prime mover and the alternator.

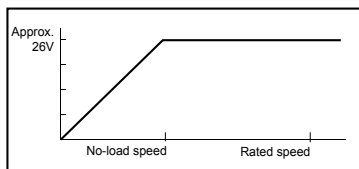

To avoid triggering errors the frequency full range set in factory must be the highest frequency of the measuring chain.

Electric isolation

The operating voltage and sensor input are electrically isolated from the output signal. Coupling of the output to evaluation device is unproblematic.

Output signal

The output signal generated is a standardized voltage of 0 ... 10 V/DC or 2 ... 10 V/DC or, respectively, a standardized current of 0 ... 20 mA or 4 ... 20 mA. The output signal follows the input signal strictly linearly (deviation < 0.1%).

The output signal can be used to supply additional devices, such as indicating instruments and limit-value switches. Attention should be paid to the maximum driver capability of the output.

Operating status display by LED

The green LED will be lit when the operating voltage is applied and the device is working normally.

Technical Data

Series VFW5..	
Operating voltage	U _o supply from terminal W
Ripple	-
Reverse voltage protection	Integrated
Overvoltage	2.5 times U _R up to 2 ms
Voltage drops	-
Power consumption	Approx. 50 mA (24 V/DC)
Galvanic isolation	Between input signal and operating voltage to the output signal
Input signal	Terminal W of a 24 V automotive alternator
Input overloading	< U _R
Output VFW5..-G.	0 ... 10 V/DC (VFW5..-G1), 2 ... 10 V/DC (VFW5..-G2), short-circuit-proof, load current 20 mA max.
Output VFW5..-I.	0 ... 20 mA (VFW5..-I1), 4 ... 20 mA (VFW5..-I2), load resistance 500 Ω max.
Noise voltage	Approx. 20 mV
Error class	IEC51-1 1.5%
Temperature sensitivity	< +/- 0.1% per 10 °K
Voltage sensitivity	< +/- 0.1% for 10% change in operating voltage
Reaction time	f=50 Hz / 0,25 s, f=100 Hz / 0,2 s, f=1 kHz / 0,1 s, f=10 kHz / 50 ms
Vibration resistance	IEC60068-T2-6 15g increased strain, characteristic 2 (10 ... 100 Hz)
Shock resistance (impact)	DIN IEC60068-T2-27 300 m/s ² with 18 ms dwell time
Climatic test	IEC60068-T2-30
Operating temperature	-20 °C ... +70 °C
Storage temperature	-45 °C ... +85 °C
Humidity	RH 96% maximum
ESD	IEC61000-4-2 +/- 8 kV
Electromagnetic field	IEC61000-4-3 10 V/m f=10 kHz ... 2000 MHz, 80% AM @ 1 kHz 10 V/m f=900 +/- 5 MHz, 50% AM @ 200 Hz 10 V/m f=1800 MHz +/- 5 MHz, 50% AM @ 200 Hz
Burst	IEC61000-4-4 +/- 2 kV supply +/- 1 kV sensor
Surge	IEC61000-4-5 sym. +/- 1 kV (R=2 Ω) asym. +/- 2 kV (R=2 Ω)
HF-susceptibility	IEC61000-4-6 3 V _{pp} 80% AM @ 1 kHz f=0.01 ... 100 MHz
LF-susceptibility	IEC60553 3 V _{pp} 0.05 ... 10 kHz
Interference field intensity	Basis CISPR 16-1, 16-2 reduced characteristic
Connection	DIN46244 flat connector, gold-plated A6.3 x 0.8
Protection class	DIN EN60529 Body IP20, terminals IP00
Mounting	Snap-fit on top-hat channel or G-channel
Installed position	Any
Body material	Thermoplastic polyester, green, fire protection class V0
Weight	55 g
Standard supply	CE requirements complied with, DIN EN 61000-6-2, DIN EN 61000-6-4, DIN EN 50155, approved by GL, BV, LR, DNV

Other Data

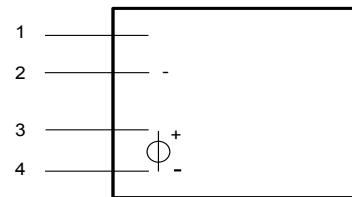
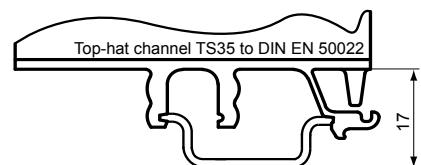
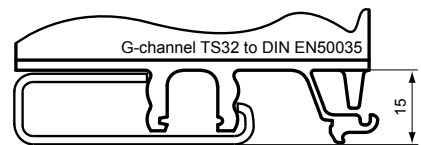
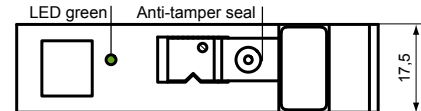
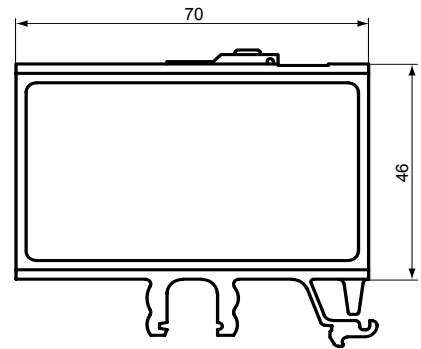

LED code

x= LED lighting
- = LED out
o= LED flashing

	LED green
Operating	x

Type key / variants

Series VFW5..:	00	01
Output: 0 ... 10 V/DC	VFW500-G1	VFW501-G1
Output: 2 ... 10 V/DC	VFW500-G2	VFW501-G2
Output: 0 ... 20 mA	VFW500-I1	VFW501-I1
Output: 4 ... 20 mA	VFW500-I2	VFW501-I2

Device code

V	Measuring transducer
FW	Input signal
FW	Frequency input for a terminal W of a 24 V automotive alternator
5	Type series
5	Type 5
00	Input range
00	0 ... 100 Hz
01	0 ... 1,200 Hz
G1	Variants
G1	Output 0 ... 10 V/DC, short-circuit-proof
G2	Output 2 ... 10 V/DC, short-circuit-proof
I1	Output 0 ... 20 mA
I2	Output 4 ... 20 mA
...	Ending frequency
...	Ending frequency in Hz (= 20 mA bzw. 10 V)

V FW 5 01 -I2 -352 (VFW501-I2-352)



NORIS Automation GmbH
Muggenhofer Strasse 95
90429 Nuremberg
Germany

Tel.: +49 911 3201-220
Fax: +49 911 3201-150
sales@noris-group.com
www.noris-group.com