

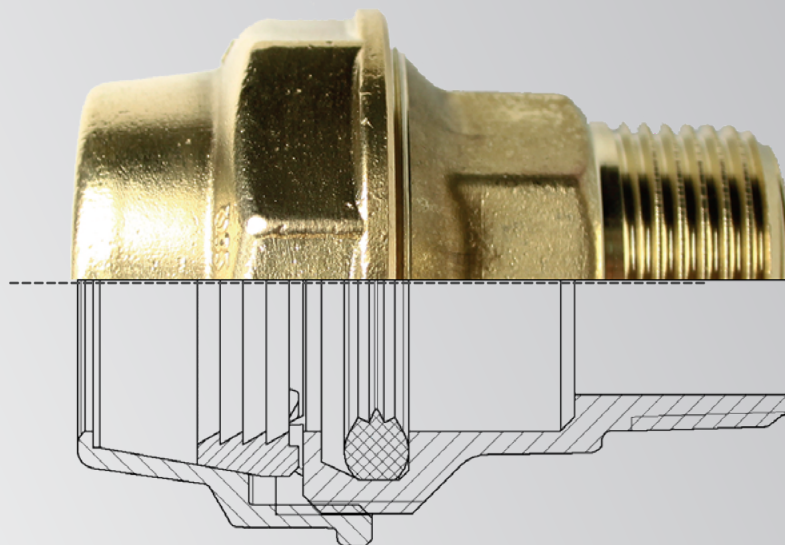

# The Connector.

Without insert pipe.



■ made  
■ in  
■ Germany

# A3

**SAFETY  
CAN BE SO  
EASY.**

# The Connector - A3

Without insert pipe for drinking water and water.



A good system does not always require special tools to be effective - our connectors without insert pipe are the best choice for everyone who likes to work fast, simple, reasonable and space-saving.

The separate sealing and clamping functions enable their clear division. Due to the pressure-depending clamping force, the pressure load adapts itself individually to the situation.

**No doubt about it - BEULCO connectors.**

## Dimensions:

- for plastic pipes:  $\varnothing$  16 mm to  $\varnothing$  75 mm

## Nominal pressure:

- PE 80 (PN 12,5), PE 100 (PN 16), PE-Xa (PN 12,5)  
acc. to DIN 16893 with relation of diameter and wall thickness SDR 11

## Kind of pipes:

- PE 80, PE 100
- PE-Xa
- PVC (with clamping ring made of brass for PVC pipes)

## Applications:

- Drinking water
- Cold and warm water up to 40 °C

## Approval:

- |                      |               |               |
|----------------------|---------------|---------------|
| • DIN 8076           | DN 20 - DN 50 | Cold water    |
| • SVGW W/TPW 157     | DN 20 - DN 50 | Cold water    |
| • ACS /13 ACC LY 190 |               | Hygiene water |



You can find the latest certificates here:

[www.beulco.de/Zertifikate](http://www.beulco.de/Zertifikate)



## Material

Our connectors are made of thermally unstressed brass and Ecobrass. Ecobrass is a lead-free alloy, qualified for the use in drinking water installations according to the European Drinking Water Directive 98/83/EC. The reliable brass is characterized by dezincification resistance and high durability.

## Sealing







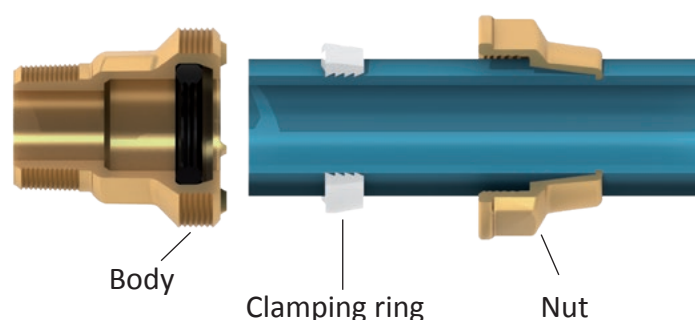













The sealing function is given by a profile seal ring which is placed in the connector body. Thus, the connector is characterized by a separate sealing and clamping function. By using a profile seal, there will be no problems with grooves on the surface of the pipe.

## Construction







The connector consists of only three components, thus it enables a quick and simple installation without any special tool. The current status of technology enables a connector without insert pipe. Therefore you only need one connector for each pipe dimension - pipe wall thickness is no longer an issue. For using our connectors with PVC pipes, a brass clamping set is necessary.



Overview

Image	Description	Page	Image	Description	Page	Image	Description	Page
	Connector male thread Model 8801	6		Elbow 90° male thread Model 8830	8		T-piece 2 PE pipe connections, outlet male & female thread Model 88182	11
	Connector male thread reduced Model 88011	6		Elbow 90° female thread Model 88310	9		Repair coupling 2 PE pipe connections Model 8806	12
	Connector male thread increased Model 88012	6		Elbow 90° male thread reduced Model 88300	9		Repair connector male thread Model 8802	12
	Connector female thread Model 88110	7		Elbow 90° male thread increased Model 88302	9		Repair connector male thread reduced Model 88021	12
	Connector female thread reduced Model 88111	7		Elbow coupling 90° Model 88301	10		Repair connector male thread increased Model 88022	12
	Connector female thread increased Model 88112	7		T-piece 3 x PE connection Model 8818	10			
	Coupling Model 8805	8		T-piece 3 x PE connection, 1 x reduced Model 8819	10			
	Coupling reduced Model 88050	8		T-piece 2 x PE pipe connection, 1 x male thread Model 88180	11			

Accessories

	Clamping set for PE/PE-Xa pipes Model 8889	13		Profile seal ring Model 8893	13		Sealing band „Loctite“ Model 9998	14
	Clamping set for PVC pipes Model 8894	13		Chamfering tool Model 8880	14		Silicone lubricant Berusil Model 8870	14
				Spare blade Model 8881				

## Installation Instructions



### Step 1

Cut the plastic pipe at a right angle.



### Step 2

Chamfer the pipe up to the inner diameter (e.g. with chamfering tool Model 8880, page 14).



### Step 3

Unscrew the forcing nut except of two turns.



### Step 4

Push the pipe into the connector to the bottom of the bore.

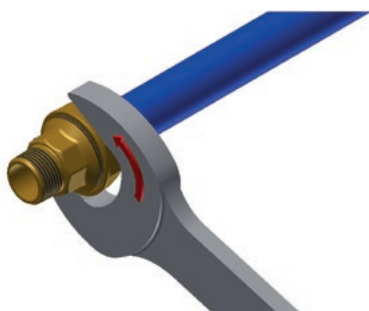

### Step 5

Tighten forcing nut firmly.

### Note:

- For oval pipes we recommend the use of insert pipes in order to guarantee the optimal holding and sealing functions.
- Corrosion protection according to DIN 50929 is necessary on site in the field of buried pipe-lining.



**CONNECTOR, MALE THREAD**

**Model 8801**

with plastic pipe connection and male thread

Item may differ from the picture.

plastic pipe dimension (mm)	thread	D	W	pkg. unit	EAN no. 4027848-
20	1/2"	●	●	10	123018
25	3/4"	●	●	10	123025
32	1"	●	●	10	123032
40	1 1/4"	●	●	5	123049
50	1 1/2"	●	●	5	123056
63	2"	●	●	2	123063
75	2 1/2"	●	●	1	123070



**CONNECTOR, REDUCED MALE THREAD**

**Model 88011**

with plastic pipe connection and reduced male thread

Item may differ from the picture.

plastic pipe dimension (mm)	thread	D	W	pkg. unit	EAN no. 4027848-
25	1/2"	●	●	10	123094
32	3/4"	●	●	10	123100
40	1"	●	●	5	123117
50	1 1/4"	●	●	5	123131
50	1"	●	●	5	123124
63	1 1/2"	●	●	2	123148
75	2"	●	●	1	123155



**CONNECTOR, INCREASED MALE THREAD**

**Model 88012**

with plastic pipe connection and increased male thread

Item may differ from the picture.

plastic pipe dimension (mm)	thread	D	W	pkg. unit	EAN no. 4027848-
16	1/2"	●	●	10	123162
20	3/4"	●	●	5	123179
25	1"	●	●	5	123186
32	1 1/4"	●	●	5	123193
40	1 1/2"	●	●	5	123209
50	2"	●	●	2	123216
75	3"	●	●	1	123230

APPLICATION	D	● = Drinking water
	W	● = Water



### CONNECTOR, FEMALE THREAD

Model 88110

with plastic pipe connection and female thread

Item may differ from the picture.

plastic pipe dimension (mm)	thread	D	W	pkg. unit	EAN no. 4027848-
20	1/2"	●	●	10	123254
25	3/4"	●	●	10	123261
32	1"	●	●	10	123278
40	1 1/4"	●	●	5	123285
50	1 1/2"	●	●	2	123292
63	2"	●	●	2	123308
75	2 1/2"	●	●	1	123315



### CONNECTOR, REDUCED FEMALE THREAD

Model 88111

with plastic pipe connection and reduced female thread

Item may differ from the picture.

plastic pipe dimension (mm)	thread	D	W	pkg. unit	EAN no. 4027848-
25	1/2"	●	●	10	123339
32	3/4"	●	●	5	123346
40	1"	●	●	5	123353
50	1 1/4"	●	●	2	123360
63	1 1/2"	●	●	2	123377
75	2"	●	●	1	123384



### CONNECTOR, INCREASED FEMALE THREAD

Model 88112

with plastic pipe connection and increased female thread

Item may differ from the picture.

plastic pipe dimension (mm)	thread	D	W	pkg. unit	EAN no. 4027848-
16	1/2"	●	●	10	123391
20	3/4"	●	●	5	123407
25	1"	●	●	5	123414
32	1 1/4"	●	●	5	123421
40	1 1/2"	●	●	2	123438
50	2"	●	●	2	123445
75	3"	●	●	1	123469



**COUPLING**  
Model 8805

with 2 equal plastic pipe connections

Item may differ from the picture.

plastic pipe dimension (mm)	D	W	pkg. unit	EAN no. 4027848-
16	●	●	10	123476
20	●	●	5	123483
25	●	●	5	123490
32	●	●	5	123506
40	●	●	2	123513
50	●	●	2	123520
63	●	●	1	123537
75	●	●	1	123544

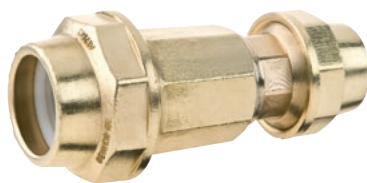

**COUPLING**  
Model 88050

with 2 plastic pipe connections, 1 x reduced

Item may differ from the picture.

plastic pipe dimension (mm)	D	W	pkg. unit	EAN no. 4027848-
40 - 32	●	●	2	123582
50 - 40	●	●	2	123599
75 - 63	●	●	1	123612



**ELBOW 90°, MALE THREAD**  
Model 8830

with plastic pipe connection and male thread

Item may differ from the picture.

plastic pipe dimension (mm)	thread	D	W	pkg. unit	EAN no. 4027848-
20	1/2"	●	●	5	123711
25	3/4"	●	●	5	123728
32	1"	●	●	5	123735
40	1 1/4"	●	●	5	123742
50	1 1/2"	●	●	2	123759
63	2"	●	●	1	123766
75	2 1/2"	●	●	1	123773



APPLICATION	D	● = Drinking water
	W	● = Water



**ELBOW 90°, FEMALE THREAD**  
Model 88310

with plastic pipe connection and female thread

Item may differ from the picture.

plastic pipe dimension (mm)	thread	D	W	pkg. unit	EAN no. 4027848-
20	1/2"	●	●	5	123940
25	3/4"	●	●	5	123957
25	3/4"		●	5	361786
32	1"	●	●	5	123971
40	1 1/4"	●	●	5	123988
50	1 1/2"	●	●	2	123995
63	2"	●	●	1	124008



**ELBOW 90°, REDUCED MALE THREAD**  
Model 88300

with plastic pipe connection and reduced male thread

Item may differ from the picture.

plastic pipe dimension (mm)	thread	D	W	pkg. unit	EAN no. 4027848-
25	1/2"	●	●	10	123797
32	3/4"	●	●	5	123803
40	1"	●	●	5	123810
50	1 1/4"	●	●	2	123827
63	1 1/2"	●	●	1	123834
75	2"	●	●	1	123841



**ELBOW 90°, INCREASED MALE THREAD**  
Model 88302

with plastic pipe connection and increased male thread

Item may differ from the picture.

plastic pipe dimension (mm)	thread	D	W	pkg. unit	EAN no. 4027848-
25	1"	●	●	5	123872
32	1 1/4"	●	●	5	123889
40	1 1/2"	●	●	5	123896
50	2"	●	●	2	123902



**ELBOW COUPLING 90°**

**Model 88301**

with 2 equal plastic pipe connections

Item may differ from the picture.

plastic pipe dimension (mm)	D	W	pkg. unit	EAN no. 4027848-
20	●	●	5	123636
25	●	●	5	123643
32	●	●	5	123650
40	●	●	2	123667
50	●	●	2	123674
63	●	●	1	123681
75	●	●	1	123698



**T-PIECE**

**Model 8818**

with 3 equal plastic pipe connections

Item may differ from the picture.

plastic pipe dimension (mm)	D	W	pkg. unit	EAN no. 4027848-
20	●	●	5	124039
25	●	●	5	124046
32	●	●	2	124053
40	●	●	1	124060
50	●	●	1	124077
63	●	●	1	124084



**T-PIECE, REDUCED**

**Model 8819**

with 2 equal and 1 reduced plastic pipe connection

Item may differ from the picture.

plastic pipe dimension (mm)	D	W	pkg. unit	EAN no. 4027848-
32 - 25	●	●	2	124121
50 - 40	●	●	1	124145

APPLICATION	D	● = Drinking water
	W	● = Water



### T-PIECE, OUTLET WITH MALE THREAD

Model 88180

with 2 equal plastic pipe connections, outlet with male thread

Item may differ from the picture.

plastic pipe dimension (mm)	thread	D	W	pkg. unit	EAN no. 4027848-
20	1/2" male	●	●	5	124213
63	2" male	●	●	1	124237
75	2 1/2" male	●	●	1	124244



### T-PIECE, OUTLET WITH MALE & FEMALE THREAD

Model 88182

with 2 equal plastic pipe connections, outlet with female and male thread

Item may differ from the picture.

plastic pipe dimension (mm)	thread	D	W	pkg. unit	EAN no. 4027848-
25	3/4" male - 1/2" female	●	●	5	124176
32	1" male - 3/4" female	●	●	2	124183



**REPAIR COUPLING**  
Model 8806

with 2 equal plastic pipe connections  
for bridging pipe damages up to 90 mm

Item may differ from the picture.

plastic pipe dimension (mm)	D	W	pkg. unit	EAN no. 4027848-
32	●	●	2	124336
40	●	●	2	124343
50	●	●	1	124350
63	●	●	1	124367



**REPAIR CONNECTOR, MALE THREAD**  
Model 8802

with plastic pipe connection and male thread  
for bridging pipe damages

Item may differ from the picture.

plastic pipe dimension (mm)	thread	bridging up to (mm)	D	W	pkg. unit	EAN no. 4027848-
32	1"	105	●	●	2	124374
40	1 1/4"	109	●	●	2	124381
50	1 1/2"	117	●	●	1	124398
63	2"	122	●	●	1	124404



**REPAIR CONNECTOR, REDUCED MALE THREAD**  
Model 88021

with plastic pipe connection and reduced male thread  
for bridging pipe damages

Item may differ from the picture.

plastic pipe dimension (mm)	thread	bridging up to (mm)	D	W	pkg. unit	EAN no. 4027848-
40	1"	109	●	●	2	124428
50	1 1/4"	117	●	●	1	124435



**REPAIR CONNECTOR, INCREASED MALE THREAD**  
Model 88022

with plastic pipe connection and increased male thread  
for bridging pipe damages

Item may differ from the picture.

plastic pipe dimension (mm)	thread	bridging up to (mm)	D	W	pkg. unit	EAN no. 4027848-
32	1 1/4"	105	●	●	2	124442
40	1 1/2"	109	●	●	2	124459

APPLICATION	D	● = Drinking water
	W	● = Water



### CLAMPING SET Model 8889

consisting of: forcing nut and plastic clamping ring  
for PE 80, PE 100 and PE-Xa pipes

Item may differ from the picture.

plastic pipe dimension (mm)	pkg. unit	EAN no. 4027848-
20	5	259519
25	5	259526
32	5	259533
40	5	259540
50	2	259557
63	2	259564



### CLAMPING SET Model 8894

consisting of: forcing nut and brass clamping ring  
for PVC pipes

Item may differ from the picture.

plastic pipe dimension (mm)	pkg. unit	EAN no. 4027848-
20	5	265398
25	5	265404
32	5	265411
40	5	265428
50	2	265435
63	2	265442
75	1	265459



### PROFILE SEAL RING

Model 8893

Item may differ from the picture.

plastic pipe dimension (mm)	D	W	pkg. unit	EAN no. 4027848-
20	●	●	10	238972
25	●	●	10	238989
32	●	●	10	238996
40	●	●	10	239009
50	●	●	10	239016
63	●	●	10	239023
75	●	●	5	239030



**CHAMFERING TOOL**

**Model 8880**

for plastic pipes up to 63 mm outer diameter  
equipped with a universal blade (94 mm) for polyethylene,  
polybutene, polypropylene, PVC and PVCc pipes  
It is extremely light and has an unlimited lifespan.

Item may differ from the picture.

material	pkg. unit	EAN no.
plastic	1	4027848-124527



**SPARE BLADE**

**Model 8881**

for chamfering tool model 8880

Item may differ from the picture.

length	pkg. unit	EAN no.
94 mm	5	4027848-261932



**SEALING BAND "LOCTITE"**

**Model 9998**

Not hardening thread sealing to  
seal conical/ cylindrical threads up to 6"  
Reversing the thread is possible.  
Temperature stability up to 130° C.  
DVGW registration no. DV-5142AU0166.  
Recommendation of KTW is available.

Item may differ from the picture.

length	D	W	pkg. unit	EAN no.
150 m per role	●	●	1	4027848-218318



**SILICONE LUBRICANT BERUSIL**

**Model 8870**

Item may differ from the picture.

	D	W	pkg. unit	EAN no.
50 ml dosing bottle	●	●	1	4027848-202225





**BEULCO® GmbH & Co. KG**

Kölner Str. 92  
D-57439 Attendorn

Postbox 1 20  
D-57425 Attendorn

Phone +49 2722 695-0  
Fax +49 2722 695-5240

[info@beulco.de](mailto:info@beulco.de)  
[www.beulco.de](http://www.beulco.de)

A3e 1/18b