

DMK 351P

Pressure Transmitter for the Process Industry

Ceramic Sensor

accuracy according to IEC 60770:
Standard: 0.35 % FSO
Option: 0.25 % FSO



Nominal pressure

from 0 ... 40 mbar up to 0 ... 20 bar

Output signal

2-wire: 4 ... 20 mA
3-wire: 0 ... 10 V
others on request

Special characteristics

- ▶ hygienic version
- ▶ different process connections (G1 1/2", diary pipe, Clamp, etc.)
- ▶ high overpressure capability



Optional versions

- ▶ IS-version
Ex ia = intrinsically safe
for gases and dusts
- ▶ diaphragm 99.9 % Al₂O₃
- ▶ customer specific versions
e.g. special pressure ranges



The pressure transmitter DMK 351P has been designed for measuring small system pressure in the food industry and chemical industry.

The DMK 351P is based on an own-developed capacitive ceramic sensor element. It features high overpressure resistance and high resistance against most of aggressive media. A variety of different process and electrical connections and an intrinsically safe version complete the range of possibilities.

Preferred areas of use are

-  Food industry
-  Chemical and petrochemical industry

Preferred used for

-  Paint and varnish
-  Viscous and pasty media



DMK 351P

Process Pressure Transmitter

Technical Data

Pressure ranges																
Nominal pressure gauge	[bar]	0.04	0.06	0.1	0.16	0.25	0.4	0.6	1	1.6	2.5	4	6	10	16	20
Nominal pressure absolute	[bar]	on request					0.4	0.6	1	1.6	2.5	4	6	10	16	20
Overpressure	[bar]	2	2	4	4	6	6	8	8	15	25	25	35	35	45	45
Permissible vacuum	[bar]	-0.2		-0.3		-0.5			-1							
Output signal / Supply																
Standard		2-wire: 4 ... 20 mA / $V_S = 9 \dots 32 V_{DC}$														
Option IS-protection		2-wire: 4 ... 20 mA / $V_S = 14 \dots 28 V_{DC}$														
Option 3-wire		3-wire: 0 ... 10 V / $V_S = 12.5 \dots 32 V_{DC}$														
Performance																
Accuracy ¹		standard: $\leq \pm 0.35 \% \text{ FSO}$ option for $p_N \geq 0.6 \text{ bar}$: $\leq \pm 0.25 \% \text{ FSO}$														
Long term stability		$\leq \pm 0.1 \% \text{ FSO} / \text{year}$ at reference conditions														
Influence effects		supply: 0.05 % FSO / 10 V load: 0.05 % FSO / k Ω														
Permissible load		current 2-wire: $R_{\max} = [(V_S - V_{S \min}) / 0.02 \text{ A}] \Omega$ voltage 3-wire: $R_{\min} = 10 \text{ k}\Omega$														
Turn-on time		700 msec														
Mean measuring rate		5 / sec														
Response time		mean response time: $\leq 200 \text{ msec}$ max. response time: 380 msec														
¹ accuracy according to IEC 60770 - limit point adjustment (non-linearity, hysteresis, repeatability)																
Thermal effect (offset and span)																
Tolerance band		$\leq \pm 1 \% \text{ FSO}$														
in compensated range		-20 ... 80 °C														
Permissible temperatures																
Permissible temperatures		medium: -40 ... 125 °C electronics / environment: -40 ... 85 °C storage: -40 ... 100 °C														
Electrical protection																
Short-circuit protection		permanent														
Reverse polarity protection		no damage, but also no function														
Electromagnetic compatibility		emission and immunity according to EN 61326														
Mechanical stability																
Vibration		10 g RMS (20 ... 2000 Hz) according to DIN EN 60068-2-6														
Shock		100 g / 1 msec according to DIN EN 60068-2-27														
Materials																
Pressure port		stainless steel 1.4404 (316L)														
Housing		stainless steel 1.4404 (316L)														
Option compact field housing		stainless steel 1.4301 (304); cable gland M12x1.5, brass, nickel plated (clamping range 2 ... 8 mm)														
Seal (media wetted)		FKM EPDM others on request														
Diaphragm		standard: ceramic Al ₂ O ₃ 96 % option: ceramic Al ₂ O ₃ 99.9 %														
Media wetted parts		pressure port, seals, diaphragm														
Explosion protection (only for 4 ... 20 mA / 2-wire)																
Approval DX 14-DMK 351 P		IBExU 05 ATEX 1070 X zone 0: II 1G Ex ia IIC T4 Ga zone 20: II 1D Ex ia IIIC T110 °C Da														
Safety technical maximum values		$U_i = 28 \text{ V}$, $I_i = 93 \text{ mA}$, $P_i = 660 \text{ mW}$, $C_i = 14 \text{ nF}$, $L_i \approx 0 \mu\text{H}$, $C_{\text{gnd}} = 27 \text{ nF}$														
Max. permissible temperature for environment		zone 0: -20 ... 60 °C for $p_{\text{atm}} 0.8 \text{ bar}$ up to 1.1 bar zone 1 and higher: -25 ... 70 °C														
Connecting cables (by factory)		cable capacity: signal line / shield also signal line / signal line: 220 pF/m cable inductance: signal line / shield also signal line / signal line: 1.5 $\mu\text{H}/\text{m}$														
Miscellaneous																
Current consumption		max. 21 mA														
Weight		min. 200 g														
Installation position		any														
Operational life		100 million load cycles														
CE-conformity		EMC-directive: 2014/30/EU														
ATEX Directive		2014/34/EU														

Wiring diagram					
2-wire-system (current)			3-wire-system (current / voltage)		
Pin configuration					
Electrical connection	ISO 4400	Binder 723 (5-pin)	M12x1 (4-pin)	compact field housing	cable colours (IEC 60757)
Supply +	1	3	1	IN +	WH (white)
Supply -	2	4	2	IN -	BN (brown)
Signal + (only 3-wire)	3	1	3	OUT +	GN (green)
Shield	ground pin	5	4		GNYE (green-yellow)
Electrical connections (dimensions in mm)					
standard		options			
ISO 4400 (IP 65)		Binder series 723 5-pin (IP 67)		M12x1 4-pin (IP 67)	
compact field housing (IP 67)		cable outlet with PVC-cable (IP 67) ²		cable outlet, cable with ventilation tube (IP 68) ³	
⇒ universal stainless steel field housing 1.4404 with cable gland M20x1.5 (ordering code 880) and other versions on request					
² standard: 2 m PVC-cable without ventilation tube (permissible temperature: -5 ... 70 °C)					
³ different cable types and lengths available, permissible temperature depends on kind of cable					

Mechanical connections (dimensions in mm)

standard

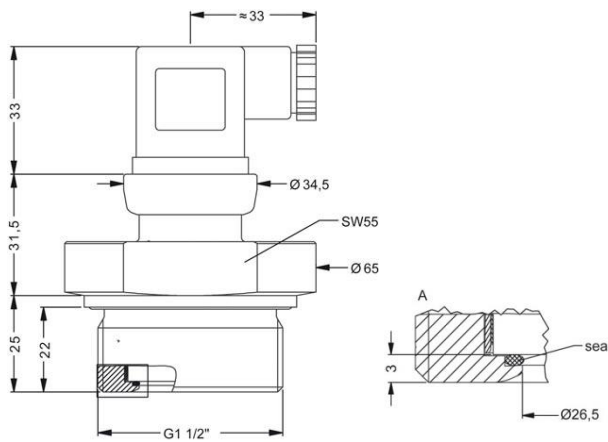

G1 1/2" DIN 3852

options

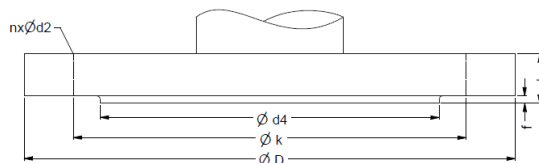

flange (DIN 2501)

dimensions in mm			
size	DN 25	DN 50	DN 80
D	115	165	200
k	85	125	160
d4	68	102	138
b	18	20	20
f	2	3	3
n	4	4	8
d2	14	18	18
p _N [bar]	≤ 40	≤ 40	≤ 16

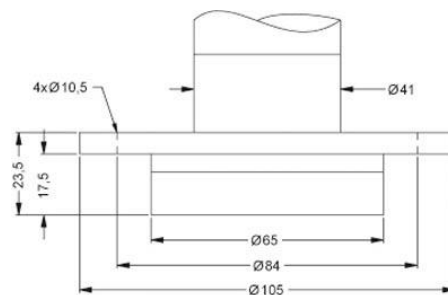

flange DRD⁴

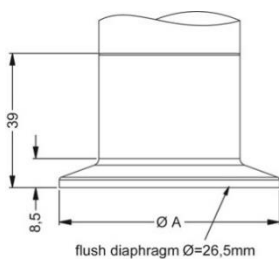

Clamp (DIN 32676)

dimensions in mm		
size	DN 32	DN 50
A	50.5	64
p _N [bar]	≤ 16	≤ 16

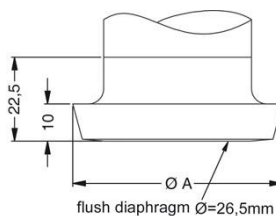

dairy pipe (DIN 11851)

dimensions in mm		
size	DN 40	DN 50
A	56	68.5

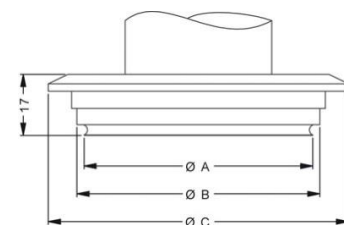

Varivent®

dimensions in mm	
size	DN 40/50
A	64
B	68
C	84

⁴ mounting flange is included in the delivery (already pre-assembled)

Ordering code DMK 351P

DMK 351P

□ □ □ - □ □ □ □ - □ - □ - □ □ □ □ - □ □ □ □ - □ - □ - □ - □ □ □ □

Pressure																			
	gauge	2	9	5															
	absolute ¹	2	9	6															
Input																			
	[mH ₂ O]																		
	[bar]																		
	0.4	0.04			0	4	0	0											
	0.6	0.06			0	6	0	0											
	1.0	0.10			1	0	0	0											
	1.6	0.16			1	6	0	0											
	2.5	0.25			2	5	0	0											
	4.0	0.40			4	0	0	0											
	6.0	0.60			6	0	0	0											
	10	1.0			1	0	0	1											
	16	1.6			1	6	0	1											
	25	2.5			2	5	0	1											
	40	4.0			4	0	0	1											
	60	6.0			6	0	0	1											
	100	10			1	0	0	2											
	160	16			1	6	0	2											
	200	20			2	0	0	2											
	customer				9	9	9	9											consult
Output																			
	4 ... 20 mA / 2-wire							1											
	0 ... 10 V / 3-wire							3											consult
	intrinsic safety 4 ... 20 mA / 2-wire							E											
	customer							9											consult
Accuracy																			
	standard:	0.35 % FSO						3											
	option for p _N ≥ 0.6 bar:	0.25 % FSO						2											
	customer							9											consult
Electrical connection																			
	male and female plug ISO 4400							1	0	0									
	male plug Binder series 723 (5-pin)							2	0	0									
	male plug M12x1 (4-pin) / metal							M	1	0									
	cable outlet with PVC cable (IP67) ²							T	A	0									
	cable outlet,																		
	cable with ventilation tube (IP68) ³							T	R	0									
	compact field housing																		
	stainless steel 1.4301 (304)							8	5	0									
	customer							9	9	9									consult
Mechanical connection																			
	G 1 1/2" DIN flush (DIN 3852)							M	0	0									
	Clamp DN 32 (DIN 32676)							C	6	2									
	Clamp DN 50 (DIN 32676)							C	6	3									
	dairy pipe DN 40 (DIN 11851) ⁴							M	7	5									
	dairy pipe DN 50 (DIN 11851) ⁴							M	7	6									
	Varivent® DN 40/50							P	4	1									consult
	flange DN 25 / PN 40 (DIN 2501)							F	2	0									consult
	flange DN 50 / PN 40 (DIN 2501)							F	2	3									consult
	flange DN 80 / PN 16 (DIN 2501)							F	1	4									consult
	customer							9	9	9									consult
Seals																			
	FKM									1									
	EPDM									3									
	customer									9									consult
Pressure port																			
	stainless steel 1.4404 (316L)									1									
	customer									9									consult
Diaphragm																			
	ceramics Al ₂ O ₃ 96 %																		2
	ceramics Al ₂ O ₃ 99.9 %																		C
	customer																		9
Special version																			
	standard																		0 0 0
	customer																		9 9 9
	customer																		consult

¹ absolute pressure from 0.04 bar up to 0.25 bar on request

² standard: 2 m PVC cable without ventilation tube (permissible temperature: -5 ... 70 °C); others on request

³ code TR0 = PVC cable, cable with ventilation tube available in different types and lengths

⁴ The cup nut has to be mounted by production of pressure transmitter with electrical connection field housing and mechanical connection dairy pipe.
The cup nut has to be ordered as separate position.

Varivent® is a brand name of GEA Tuchenhagen GmbH