

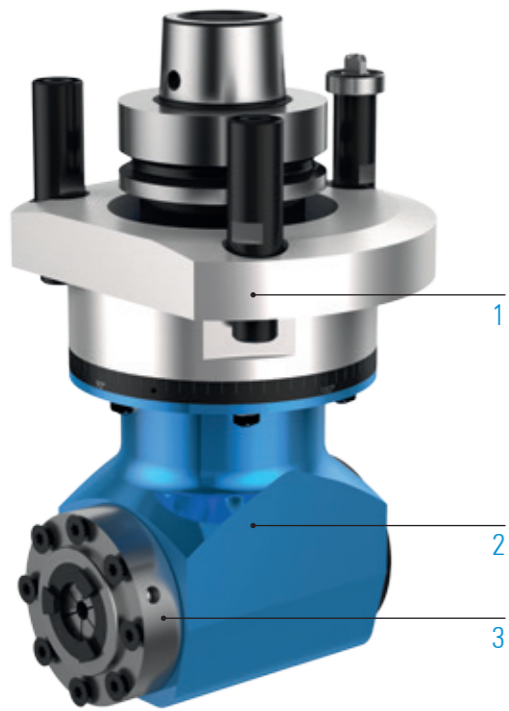



SINGLE SIDED ANGLE HEAD – CLASSIC LINE MONO

TECHNICAL DATA





Lubrication **Grease**
 Max. drive speed n_2 **15,000rpm**
 Transmission ratio ($n_1: n_2$) **1:1.2**
 Max. drive torque M_2 **25Nm**
 Weight **about 5 kg**





STANDARD DESIGN

- 1  Machine connection
HSK - F63
- 2  Head length
M
- 3  Output spindle
Centring Ø40/ collet chuck ER25A

MACHINING

-  Drilling
-  Milling
-  Sawing

SPECIFICATIONS

-  Number of output spindles **1**
-  Axis angle **90°**
-  C-angle **360°**
-  Grease lubrication

VIDEO

 Angle head - live in the application
 Scan QR code or go to:
www.youtube.com/BENZWerkzeugsysteme

ORDER DIRECTLY

 Inquiry form:
www.benz-tools.de/en/products

ADDITIONAL OPTIONS: MODULAR DESIGN



MACHINE CONNECTION

- | | | | | |
|--|--|---|--|---|
| 
HSK - F63
BIESSE | 
SK 30
BIESSE | 
HSK - F63
Busellato | 
HSK - F63
Felder | 
HSK - F63
HOMAG / WEEKE /
WEINMANN |
| 
HSK - F63
IMA | 
HSK - F63
Masterwood | 
HSK - F63
SCM | 
HSK - F63
SCM | 
HSK - F63
Weinig |

 For further information see p. 106













HEAD LENGTH

- S** **M** **L**

 For further information see p. 107



OUTPUT SPINDLE

- | | | | | |
|---|---|---|---|--|
| 
Collet chuck
ER25M | 
Collet chuck
ER32 | 
Centring Ø40/
Collet chuck
ER25A | 
Centring Ø30/
Weldon Ø10 | 
Arbor Ø30,
tool length
1,5-6 mm |
| 
Arbor Ø30,
tool length
1,5-16 mm | 
Arbor Ø30,
tool length
1,5-33 mm | 
Arbor Ø30,
tool length
1,5-52 mm | 
Arbor Ø30,
tool length
1,5-63 mm | 
BENZ
Solidfix® S3 |

 For further information see p. 108