



English



User Manual

UPSI-IP-3 Series

UPS SYSTEM
IP65



Legend of used symbols

Symbol	Description
	Attention! Important hazard warning.
	Do not dispose of in the domestic waste.
	Warning of electrical voltage.

Revision Directory

Date	Change
21.09.2022 Revision 1-0	Initial version



A Brief specification

UPSI-2406IP-38AC

24V / 6 A

- ✓ **Outdoor AC/DC UPS for extreme environments in robust aluminium housing with IP65 protection**
- ✓ **Already integrated LiFePO4 energy storage (330 Wh)**
- ✓ **Temperature range -20...+50°C**
- ✓ **Intelligent input current regulation**
- ✓ **Regulated output voltage in battery mode**
- ✓ **Pressure compensation element to prevent condensation inside**
- ✓ **Input and output cable firmly installed**
- ✓ **Optionally available: mounting sets for masts**



TECHNICAL DATA	
Input voltage*	100...240 VAC nominal ($\pm 10\%$), active PFC
Input frequency	50...60 Hz nominal ($\pm 10\%$)
Input current	$I_{IN\ NOM}$ ($I_{OUT} = 6\ A, I_{CHARGE} = 0$): 0.74 A at 220VAC _{IN} / 1.58 A at 100 VAC _{IN} $I_{IN\ MAX}$ ($I_{OUT} = 6\ A, I_{CHARGE} = \max$): 0.9 A at 220VAC _{IN} / 2.1 A at 100 VAC _{IN} $I_{IN\ CHARGE}$ ($I_{OUT} = 0, I_{CHARGE} = \max$): 0.3 A at 220VAC _{IN} / 0.65 A at 100 VAC _{IN}
Inrush current	<100A (at $I_{IN} = 220\ VAC$)
Efficiency	App. 90.5...91.5 % at $I_{IN\ NOM}$ ($I_{OUT} = 6\ A, I_{CHARGE} = 0$) App. 87.5...88.5 % at $I_{IN\ CHARGE}$ ($I_{OUT} = 0, I_{CHARGE} = \max$)
Output voltage*	Normal mode: 24 VDC, backup mode: 23.5 VDC, (voltage drop up to 0.5 V, depending on load)
Output current	6 A nominal
Capacitive load	3000 μF (in normal mode, at start, 0 A load)
Charging method	CC / CV / CP
Protection	Overcurrent protection and short circuit protection (UPS) at output, Overtemperature protection (AC-DC converter)
Battery cold start function	Yes
Mast mounting set	Optional available
Battery Technology	LiFePO4: 25 Ah / 330 Wh
Backup time	See page after next

Backup fuse	B16 230V AC 20 A / 120V AC, IEC/EN Listed breaker, Type B
I _{cw} (Rated Short-Time-Withstand)	<6 kA
Input and output cable	AC input cable: Lapp ÖLFLEX® CLASSIC 100 BK 0,6/1 kV, 3x1.5mm ² (incl. PE), length app. 3 m starting from chassis, open end DC output cable: Lapp ÖLFLEX® CLASSIC 110 LT, 2x1.5mm ² , length app. 3 m starting from chassis, open end
Operating temperature	Operating: -20...+50 °C (incl. charge and discharge)** Storage / Transport: -20...+55 °C, (recommended SOC at storage: 80 %)
Operating altitude	≤ 3000m
Dimensions W / H / D	130 x 130 x 370 mm ± 0.5mm (without cable outlets and mounting brackets)
Weight	7.7 kg (device without cables)
Degree of protection	IP65 (EN 60529)
Protection class	1
EMC	EN IEC 62040-2:2018, EN IEC 61000-3-2:2019
Standards	EN IEC 62040-1
Approvals	UL: n.a. CB Scheme: IEC 62040-1

Unless otherwise specified, the values apply to measurements at +25 °C

*From/to housing , without cables

** -20...0 °C: At sub-zero temperatures, the charging time increases according to the physical properties of the cells (increased internal resistance).

Backup time* UPSI-2406IP-38AC

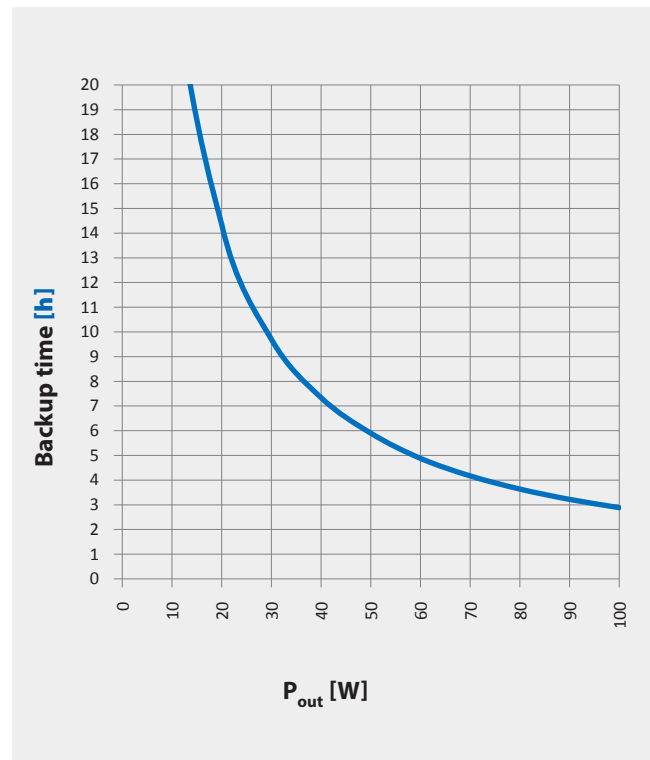
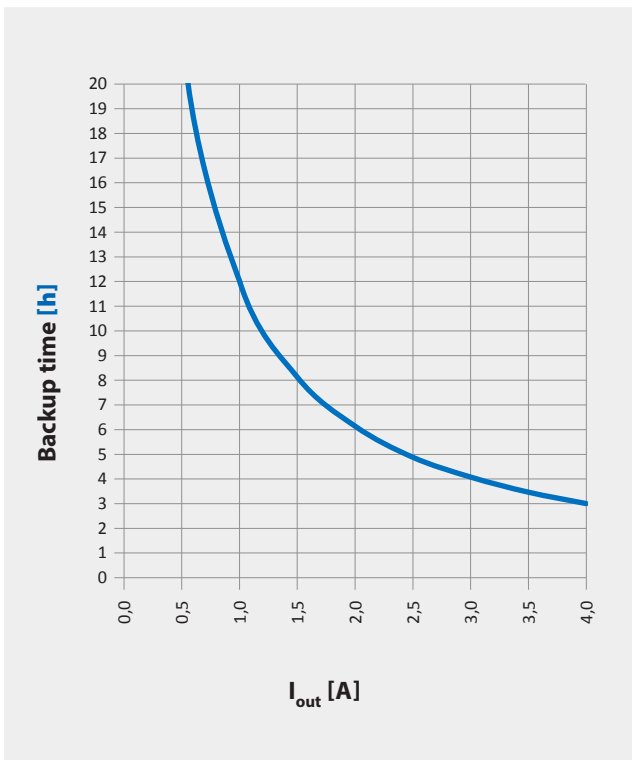
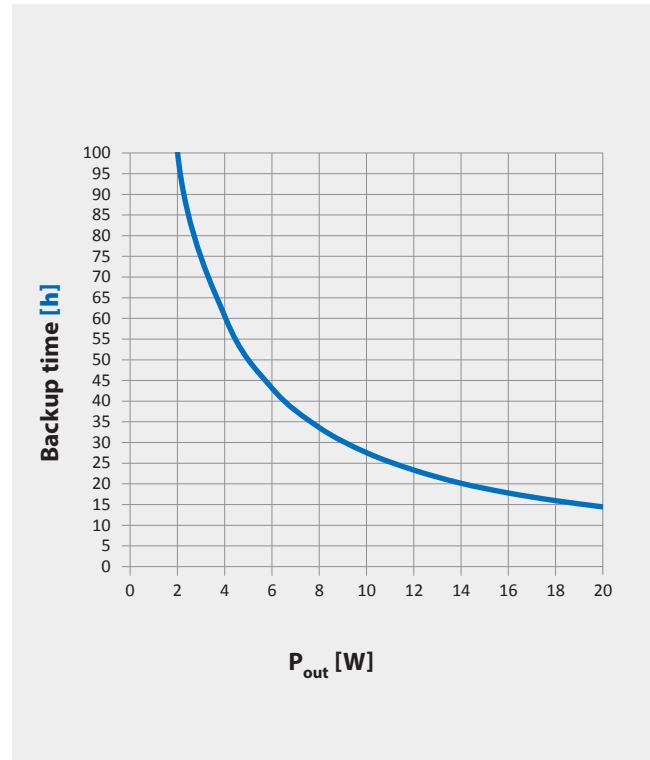
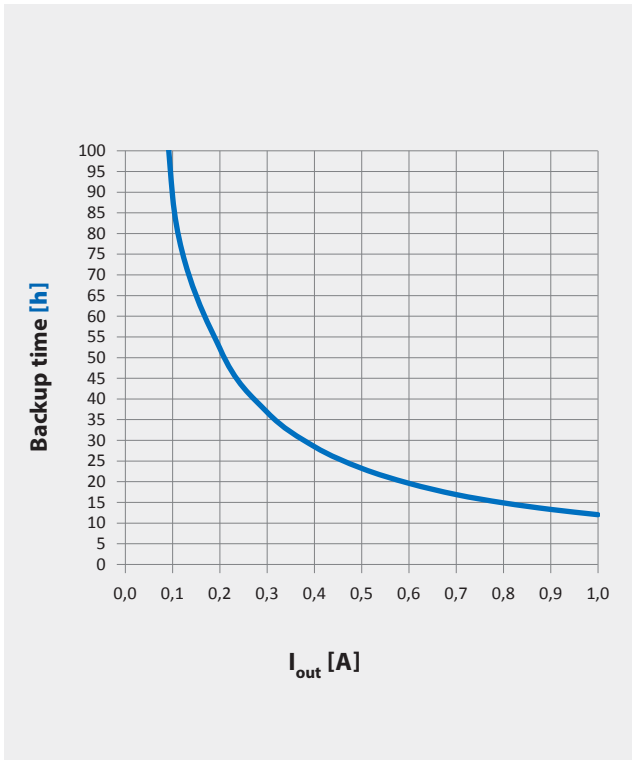

*Backup time depends on battery capacitance, load and temperature. At very high or low temperatures a reduction of backup time occurs. Unless otherwise specified, the values apply to measurements at +25 °C

Derating UPSI-2406IP-38AC

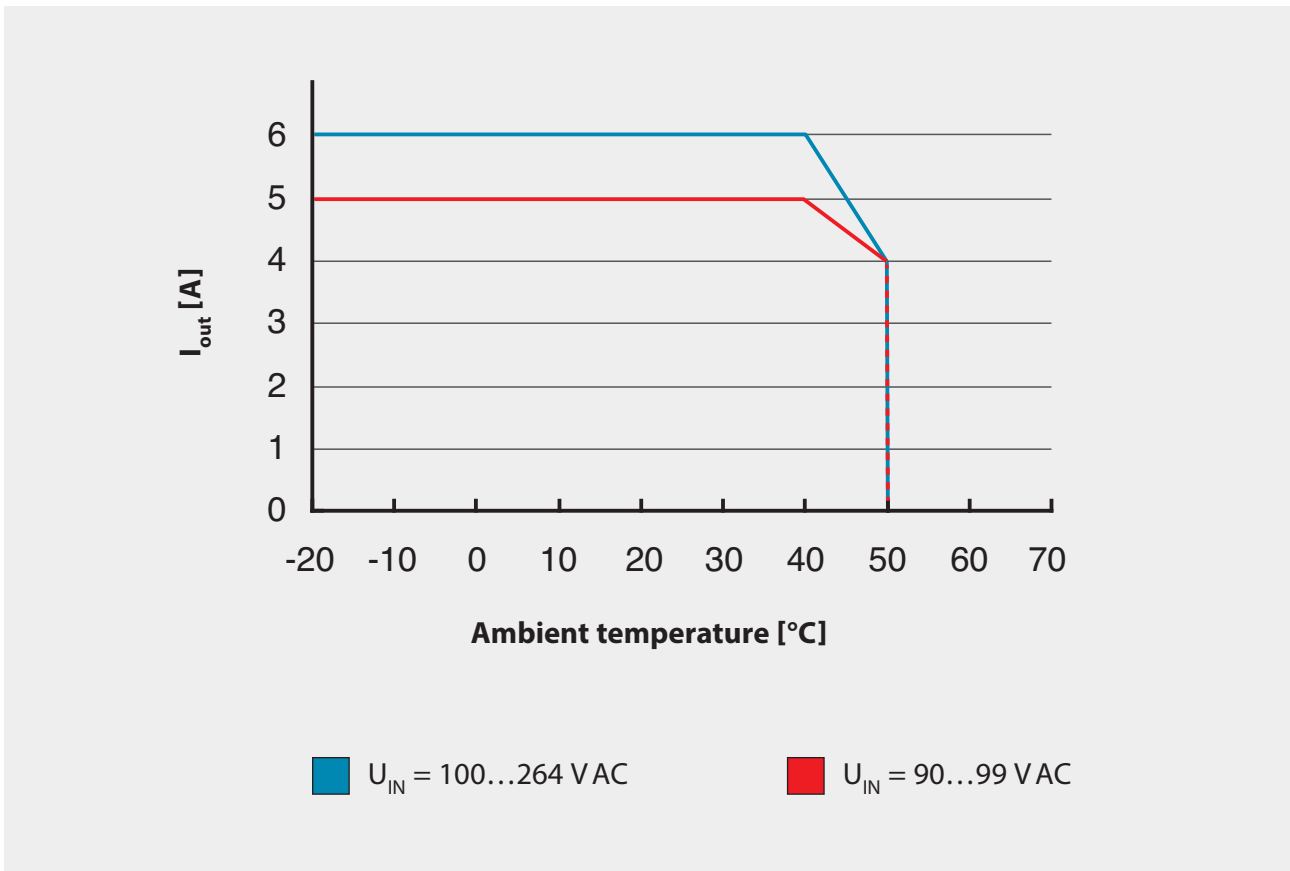

-20...0 °C: At sub-zero temperatures, the charging time increases according to the physical properties of the cells (increased internal resistance).

A	Brief specification UPSI-2406IP-38AC.....	4
B	Introduction and description	9
B1	Description of the product and its functions	9
B2	Intended use – devices.....	10
B3	Intended use – connecting cables.....	10
C	Safety instructions	11
C1	Preventive measures and rules when operating the UPS system.....	11
D	Technical Data	12
D1	General Technical Data.....	12
D2	Drawing.....	19
E	Name / Address / Support E-Mail / Phone number of the manufacturer	19
F	General Data	20
F1	Assembly and installation advice	20
F2	Convection, installation position and mounting.....	20
F3	Description of connectors.....	21
F4	Connection	22
F5	Initial operation	24
F6	Charging time	24
F7	Overcurrent / Short circuit / Overtemperature protection	24
F8	Backup time in battery mode	25
F9	Behaviour in case of exceeding maximum backup time.....	25
F10	Battery start.....	25
F11	Dynamic Powerboost.....	25
F12	Status LED.....	28
F13	Shutdown diagram.....	29
F14	Recommendations for a long UPS service life.....	30
F15	Maintenance	30
F16	Disposal.....	30
F17	Disclaimer	30
F18	Scope of delivery.....	30

B Introduction and description

Read carefully before initial operation!

This manual shall help the user to get familiar with the product and its components and features. It shall provide information as accurately and completely as possible.

The manual as well as all documents has to be read and followed strictly before installation. Otherwise in certain situations warranty and guarantee can be cancelled partly or completely. Any liability on the part of Bicker Elektronik is excluded for possible existing errors as well as non-compliance with the instructions for use and installation.

B1 Description of the product and its functions

The UPSI-2406IP-38AC (hereinafter also called UPS) is a AC/DC UPS systems with numerous digital features and high performance. The UPSI-2406 is combined with an upstream AC/DC converter as well as an already integrated LiFePO₄ energy storage. The primary use of the UPS is to secure the supply during power failures and/or voltage fluctuations. The application which should be protected is connected to the output of the UPS. The device has IP65 protection and has been developed for the specific use under extreme conditions.

The device requires a rated dimensioned AC voltage (100...240 VAC nominal) at the input. After the input voltage is applied, the UPS works in normal mode automatically. The output is activated and the integrated energy storage device is charged simultaneously. The input current is dynamic and depends on the load current at the output and the current battery charge current. The green status LED at the bottom of the device lights up continuously when the UPS is in this state.

If the input voltage drops below the lowest nominal value, the UPS is switched to battery mode (also back-up mode). In this state, the application at the UPS output is supplied via the energy storage device. The backup time (also buffer time) depends on the value of the output current (= load current) of the UPS. An important feature is that the output voltage in battery mode is always regulated to approximately 23.5VDC and does not decrease as the voltage of the energy storage device drops. If the UPS operates in battery mode, the status LED is slowly flashing (1 Hz flashing). After having been operated completely in battery mode, the recharging of the LiFePO₄ battery has to happen within two weeks.

When the input voltage returns, the UPS is automatically switched back to normal mode and charging of the energy storage device is continued.

The UPS can also be used for user-initiated shutdowns of the supply voltage or cycles. Application examples are the replacement of larger batteries in vehicles in which the electronics should continue to be supplied, the opening and closing of safety valves after a malfunction or the shutdown of a system.

A pressure compensating element on the bottom side of the housing prevents condensation inside the device.

B2 Intended use – devices

This device is primarily designed for use under difficult and extreme environmental conditions and can be used both indoors and outdoors. It has been developed for professional use in areas such as industrial control, communication and measurement technology. This product must not be used in devices or systems in which a malfunction leads to serious injuries or endangers human life.

Unlike the standard models of the UPSI series (Open Frame or DIN-rail mounting), this device has IP65 protection. This means that the components mounted in the housing (UPS PCB and energy storage) are completely protected against contact and dust (IP6x) as well as against water jets from any direction (IPx5) according to EN 60529.

B3 Intended use – connecting cables

The fixed connection cables may only be used with the device in accordance with the manufacturer's specifications.

The input cable (type „Typ „ÖLFLEX® CLASSIC 100 BK 0,6 / 1 kV“ from the LAPP brand) as well as the output cable (type „ÖLFLEX® CLASSIC 110LT“ from the LAPP brand) are coldflexible control and connection cables for occasional flexible use and fixed installation under medium mechanical stress. They are also suitable for use in dry, damp or wet areas.

If using outdoors, observe the indicated temperature range. They are for occasional, non-automated movements, also when temperatures are low. They meet the requirements for slow rotary movements. The maximum tensile load is 15 N/mm² of conductor cross-section during installation and operation. Compulsory guidance is not permitted.

C Safety instructions



WARNING!

Disregarding of following issues can result in electric shock, fire, serious injury or death.

1. Care must be taken to ensure proper and professional connection of the device.
2. The device must not be exposed to fire and temperatures outside the specification.
3. The device may only be exposed to water jets up to a maximum water volume of 12.5 l/min (according to EN 60529).
4. The device must not be opened, short-circuited, reversed, overheated or otherwise soldered/welded.
5. Improper use and opening of the device will void the warranty.
6. Changes or attempts to repair the device are to be omitted.
7. Effects of foreign objects on the device must be avoided (e.g. metal parts).
8. Do not put obviously damaged devices into operation (e.g. dents, burn marks, rough contamination).
9. Device must not be dropped.
10. All parts of the device and accessories must not be eaten or swallowed.
11. The device must not be operated with voltage and current values outside of the specification.
12. The UPS is supplied with voltage from both the input source and the energy storage. The latter is still energized even after the input source has been disconnected.
13. The input and output cables have to be professionally secured against pulling.
14. The device may only be used as intended.
15. The national accident prevention and safety regulations must be observed.
16. The assembly of the device and the electrical installation have to be state of the art.
17. The electrical, thermal and mechanical limit values have to be observed.

C1 Preventive measures and rules when operating the UPS system

The voltage drop of the lines has to be kept in mind! A high load current at the output can lead to high voltage drops if the lines are too long. If the voltage drop is too high, the threshold value may be undershot and an unintentional power fail may be triggered. Even after the upstream supply has been disconnected, the device continues to run for some time after the shortfall of the load sensor (no load detection).

A short direct at the output of the device can cause damage or destruction of the UPS. In the event of a fault, electrolytes can escape in liquid and gaseous form.

D Technical Data

D1 General Technical Data

INPUT DATA		
Input voltage	100...240 VAC nominal ($\pm 10\%$), active PFC	
Input frequency	50...60 Hz nominal ($\pm 10\%$)	
Inrush current	<100 A (bei $I_{IN} = 220$ VAC)	
Current consumption	At 220 VAC_{IN}	At 100 VAC_{IN}
$I_{IN\ NOM}$ ($I_{OUT} = 6$ A, $I_{CHARGE} = 0$)	0.74 A	1.58 A
$I_{IN\ MAX}$ ($I_{OUT} = 6$ A, $I_{CHARGE} = \max$)	0.9 A	2.1 A
$I_{IN\ DYN}$ ($I_{OUT} = I_{DYN.BOOTST}$, $I_{CHARGE} = 0$)*	1.0 A	2.2 A
$I_{IN\ NO-LOAD}$ ($I_{OUT} = 0$, $I_{CHARGE} = 0$)	<100 mA	<100 mA
$I_{IN\ CHARGE}$ ($I_{OUT} = 0$, $I_{CHARGE} = \max$)	0.3 A	0.65 A
Power consumption	At 220 VAC_{IN}	At 100 VAC_{IN}
$P_{IN\ NOM}$ ($I_{OUT} = 6$ A, $I_{CHARGE} = 0$)	155 W	156 W
$P_{IN\ MAX}$ ($I_{OUT} = 6$ A, $I_{CHARGE} = \max$)	190...196 W	205...210 W
$P_{IN\ DYN}$ ($I_{OUT} = I_{DYN.BOOTST}$, $I_{CHARGE} = 0$)*	220 W	221 W
$P_{IN\ NO-LOAD}$ ($I_{OUT} = 0$, $I_{CHARGE} = 0$)	<2 W	<2 W
$P_{IN\ CHARGE}$ ($I_{OUT} = 0$, $I_{CHARGE} = \max$)	62...63 W	63...64 W
Efficiency	App. 90.5...91.5 % at $I_{IN\ NOM}$ ($I_{OUT} = 6$ A, $I_{CHARGE} = 0$) App. 87.0...88.5 % at $I_{IN\ CHARGE}$ ($I_{OUT} = 0$, $I_{CHARGE} = \max$)	
Internal input fuse	2x 5 A / 250 VAC	
Switch-on time	<5 sec	
Switch-on time battery start (BS)	<5 sec	
Backup fuse	B16 230V AC 20 A / 120V AC, IEC/EN Listed breaker, Type B	

All specifications at the housing inlet/housing outlet, without line losses, at ambient temperature of 25°C

*Max. 58 sec., depending on output power (see also „F11 Dynamic Powerboost“)

OUTPUT DATA – NORMAL MODE	
Output voltage*	24 VDC
Output voltage range*	24...23.4 VDC max. (depending on load)
Capacitive load	3000 µF (at start, 0 A load)
Output current	
I_{NOM}	6 A
$I_{DYN.BOOST}^*$	6...8 A
I_{SFB}	30 A (5 ms)
Output power	
$P_N (I_{OUT} = 6 A, I_{CHARGE} = 0)$	144 W
$P_{DYN.BOOST} (I_{OUT} = I_{DYN.BOOST}, I_{CHARGE} = 0)^*$	144...192 W
Overcurrent shutdown	6...8 A for max. 58 s*; 8...10.8 A for max. 100 ms; >10.8 A for max. 5 ms
Short-circuit proof	Yes
No-load proof	Yes

OUTPUT DATA – BATTERY MODE	
Output voltage	23.5 VDC
Output voltage range*	23.5...22.5 VDC (depending on load)
Output current	
I_{NOM}	6 A
$I_{DYN.BOOST}$	6...8 A
I_{SFB}	30 A (5 ms)
Output power	
$P_N (I_{OUT} = 6 A, I_{CHARGE} = 0)$	141 W
$P_{DYN.BOOST} (I_{OUT} = I_{DYN.BOOST}, I_{CHARGE} = 0)^*$	141...192 W
Overcurrent shutdown	6...8 A for max. 58 s*; 8...10.8 A for max. 100 ms; >10.8 A for max. 5 ms
Short-circuit proof	Yes
No-load proof	Yes
Load current for battery start	6 A max. (SOC ≥ 10 %)
Switching time normal mode >> battery mode	<1 ms

All specifications at the housing inlet/housing outlet, without line losses, at ambient temperature of 25°C

*Max. 58 sec., depending on output power (see also „F11 Dynamic Powerboost“)

ENERGY STORAGE	
Installed type	BP-LFP-13250S
Battery technology	LiFePO4
Charging method	CC / CV / CP
Nominal voltage U_N	13.2 V
End-of-charge voltage	13.8 V
Battery charging current	$\leq 0.2C$ (4.5...5 A)
Undervoltage protection	As soon as the first cell reaches 2.5 V
Nominal capacity	25 Ah / 330 Wh
Charging time (at $I_{CHARGE} = \max$, $T_{AMB} = 25^\circ C$)	App. 6 h...7 h
Buffer time (at $I_{OUT} = 6 A$, $T_{AMB} = 25^\circ C$)	App. 1 h 50 min

DATA AC INPUT CABLE	
Type of cable	ÖLFLEX® CLASSIC 100 BK 0,6/1 kV – connection and control cable, 3G1,5
Article No.	Lapp 1120463
Features	Flame-retardant according to IEC 60332-1-2, UV and weather-resistant according to ISO 4892-2, ozone-resistant according to EN50396, coldflexible up to -30°C
Cable construction	Fine wire strands of bare copper; PVC conductor isolation, cold resistant, Cores stranded in layers; Sheath: PVC, cold-resistant, black
Length	3 m
Outside diameter cable	10.1 mm
Stranded wire cross section	2x Stranded wire (Power): each 1.5mm ² ; 1x Stranded wire (PE): 1.5mm ²
Minimum bending radius	Occasional flexing: 15x outer diameter Fixed installation: 4x outer diameter
Temperature range	Occasional flexing: -30°C...+70°C Fixed installation: -40°C...+80°C

DATA DC OUTPUT CABLE	
Type of cable	ÖLFLEX® CLASSIC 110 LT – PVC-control cable, 2X1,5
Article No.	Lapp 1120750
Features	Flame-retardant according to IEC 60332-1-2, UV and weather-resistant according to ISO 4892-2, ozone-resistant according to EN 50396, coldflexible up to -30°C
Cable construction	Fine wire strands of bare copper; PVC conductor isolation, cold resistant, Cores stranded in layers; Sheath: PVC, cold-resistant, black
Length	3 m
Outside diameter cable	6.3 mm
Stranded wire cross section	2x Stranded wire (Power): each 1.5mm ²
Minimum bending radius	Occasional flexing: 15x outer diameter Fixed installation: 4x outer diameter
Temperature range	Occasional flexing: -30°C...+70°C Fixed installation: -40°C...+80°C

AC input

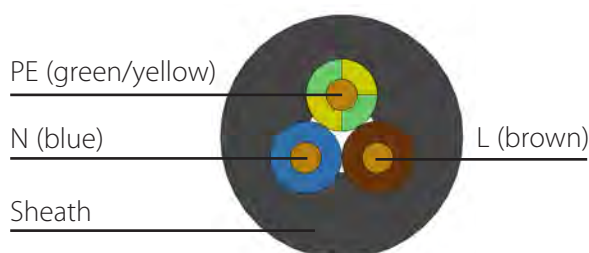

DC output

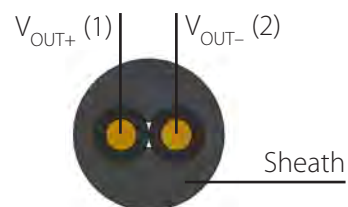

GENERAL DATA	
Flammability class according to UL 94	V0
Weight	7.7 kg (device without cables)
UPS connection in parallel	No
UPS connection in series	No
HOUSING	
Degree of protection	IP 65
Protection class	I
Mounting type	Mast or surface mounting (or equal)
Housing version	Aluminium-cast housing, milled, FORMODAL® 024, natural anodised
Dimension W / H / D	130 mm / 130 mm / 370 mm (without cable outlets and mounting brackets)
ENVIRONMENTAL CONDITIONS	
Ambient temperature (operation)	-20...+50 °C
Ambient temperature (start up without load)	-20 °C
Ambient temperature (storage / transport)	-20...+55 °C (recommended SOC at storage: 80%)
Permitted humidity	5...95 %
Operating altitude	≤3000 m
Climate class	3K24 (EN 60721-3-3:2020-5)
Degree of pollution	4
Overvoltage category	2
Indoor / Outdoor use	Yes / Yes
STANDARDS	
EMC	EN 62040-2, EN 61000-3-2, EN 62040-1
Safety	
APPROVALS	
UL	n.a.
CSA	n.a.
CB Scheme	IEC 62040-1

INTERFERENCE IMMUNITY ACCORDING TO EN 62040-2 Uninterruptible Power Supply Systems – Part 2: Electromagnetic compatibility requirements (EMC)	
Basic standard	Fulfilled requirements according to EN 62040-2
Electrostatic discharge EN 61000-4-2 Contact discharge Air discharge Comment	±4 kV ±8 kV Criterion A
Electromagnetic HF field EN 61000-4-3 Frequency range Test field strength Frequency range Test field strength Comment	80 MHz...1 GHz 10 V/m 1 GHz...6 GHz 3 V/m Criterion A
Fast transients (Burst) EN 61000-4-4 Test voltage Comment	±2 kV Criterion A
Surge voltage load (Surge) EN 61000-4-5 Test voltage L–N Test voltage L–PE, N–PE Comment	±1 kV ±2 kV Criterion A
Induced radio frequency fields EN 61000-4-6 Frequency range Interference level Comment	0.15...80 MHz 10 V / AM80% / 1 kHz (Sine) Criterion A
Power frequency magnetic field immunity EN 61000-4-8 Test level Comment	30 A/m Criterion A

LEGEND	
Criterion A	Normal operating behaviour within the defined limits.
Criterion B	Temporary impairment of the operating behaviour, that is corrected by the device itself.

EMISSION ACCORDING TO EN 62040-2 Uninterruptible Power Supply Systems – Part 2: Part 2: Electromagnetic compatibility requirements (EMC)	
Basic standard	Fulfilled requirements according to EN 62040-2
Conducted emission from the power port CISPR 22 Frequency range Comment	150 kHz–30 MHz Class A
Electric field radiated emission CISPR 22 Frequency range Comment	30 MHz–1 GHz Class A*
Electric field radiated emission CISPR 22 Frequency range Comment	1 GHz–6 GHz Class A

**To improve the emitted interference, Bicker Elektronik recommends installing the "Würth 74272722" ferrite (not in scope of delivery) in the DC output cable of the UPS directly after the housing outlet (2 turns).*

HARMONIC CURRENTS ACCORDING TO EN 62040-2 Uninterruptible Power Supply Systems – Part 2: Part 2: Electromagnetic compatibility requirements (EMC)	
Basic standard	Fulfilled requirements according to EN 62040-2
Measurement of harmonic currents EN 61000-3-2 Comment	Passed

D2 Drawing

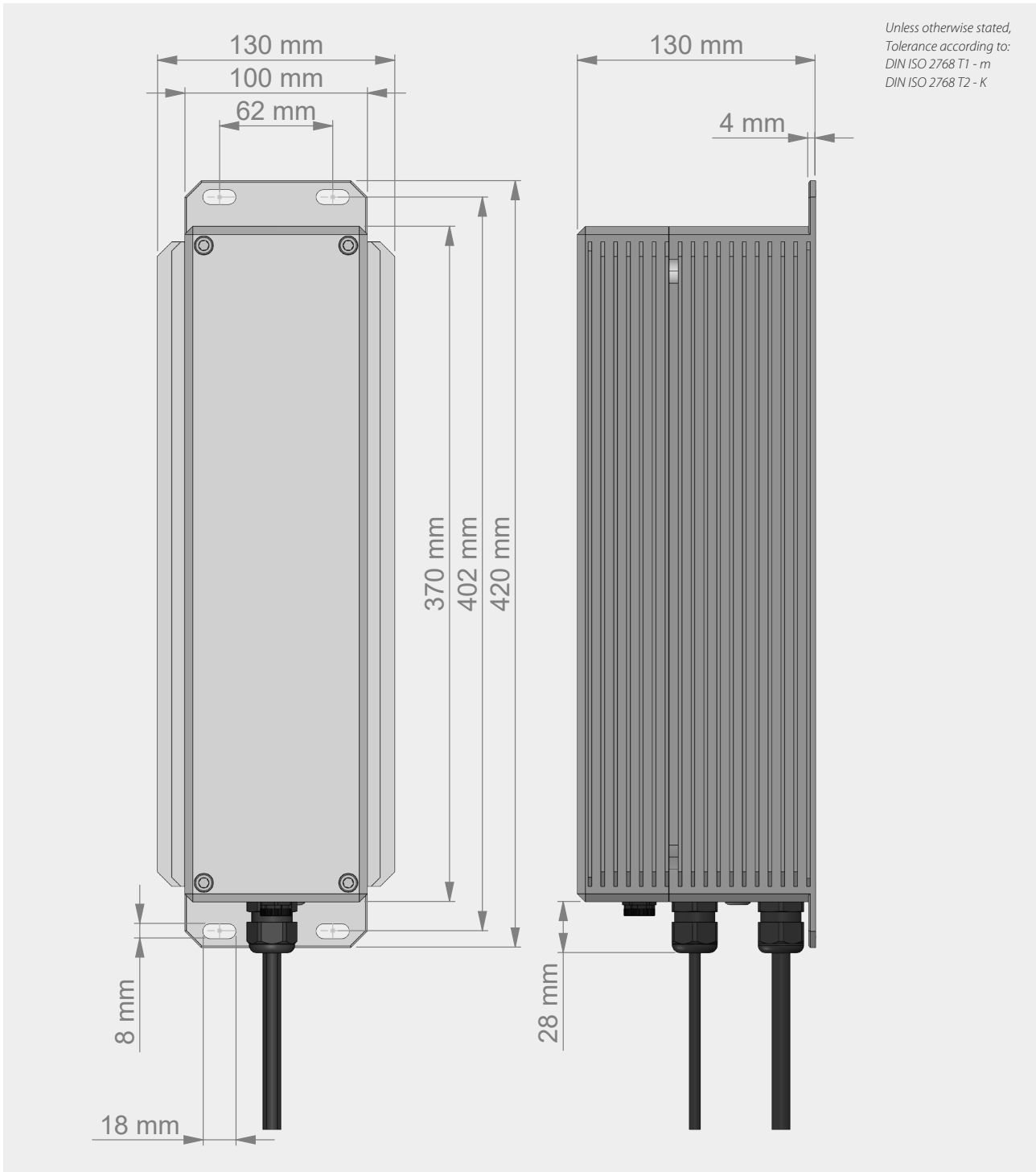

E Name / Address / Support E-Mail / Phone number of the manufacturer

Bicker Elektronik GmbH · Ludwig-Auer-Straße 23 · 86609 Donauwörth · Germany

E-Mail: support@bicker.de · Tel.: +49 (0) 906 70595-0

F General Data

F1 Assembly and installation advice



The installation of devices that are not ready to be plugged in is to be carried out by the respective network operator or by a registered specialist company, who will also assist in obtaining the approval of the respective network operator for the installation of the device.

F2 Convection, installation position and mounting

In order to achieve the best possible convection, the device has to be mounted vertically on a stable wall or other surface. This is the only way to operate in the specified technical areas. Other installation methods are possible, taking into account the reduced performance range.

Required fastening aids such as dowels or other systems are to be selected according to the mounting surface used.

A distance of at least 100 mm (10 cm) in all directions from the housing wall to other, neighboring devices should be maintained. The devices comply with the IP protection class 65.

- Ⓐ 4x Hex spax screw,
6 mm x 60 mm or longer
- Ⓑ 4x tension washer, 6.4 mm,
DIN 6796
- Ⓒ 4x 8 mm mounting dowels for wall
attachment
- Ⓓ 8 mm hole

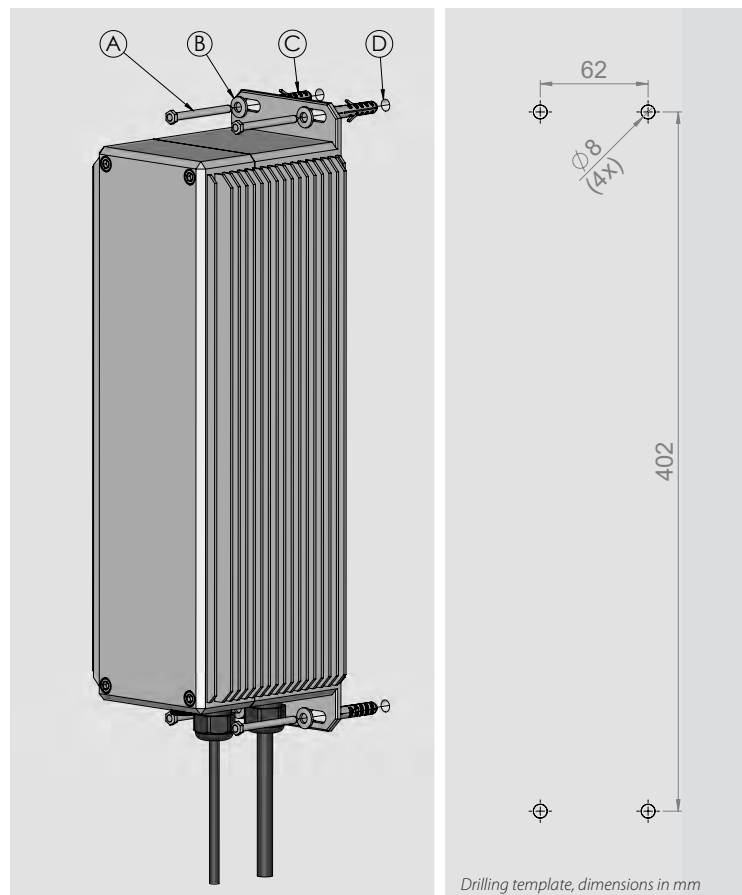

F3 Description of connectors

AC INPUT

COLOUR	FUNCTION
BROWN	L / phase conductor
GREEN / YELLOW	PE / protective earth
BLUE	N / neutral conductor



DC OUTPUT

PIN	FUNCTION
1	Vout +
2	Vout - (GND)



F4 Connection

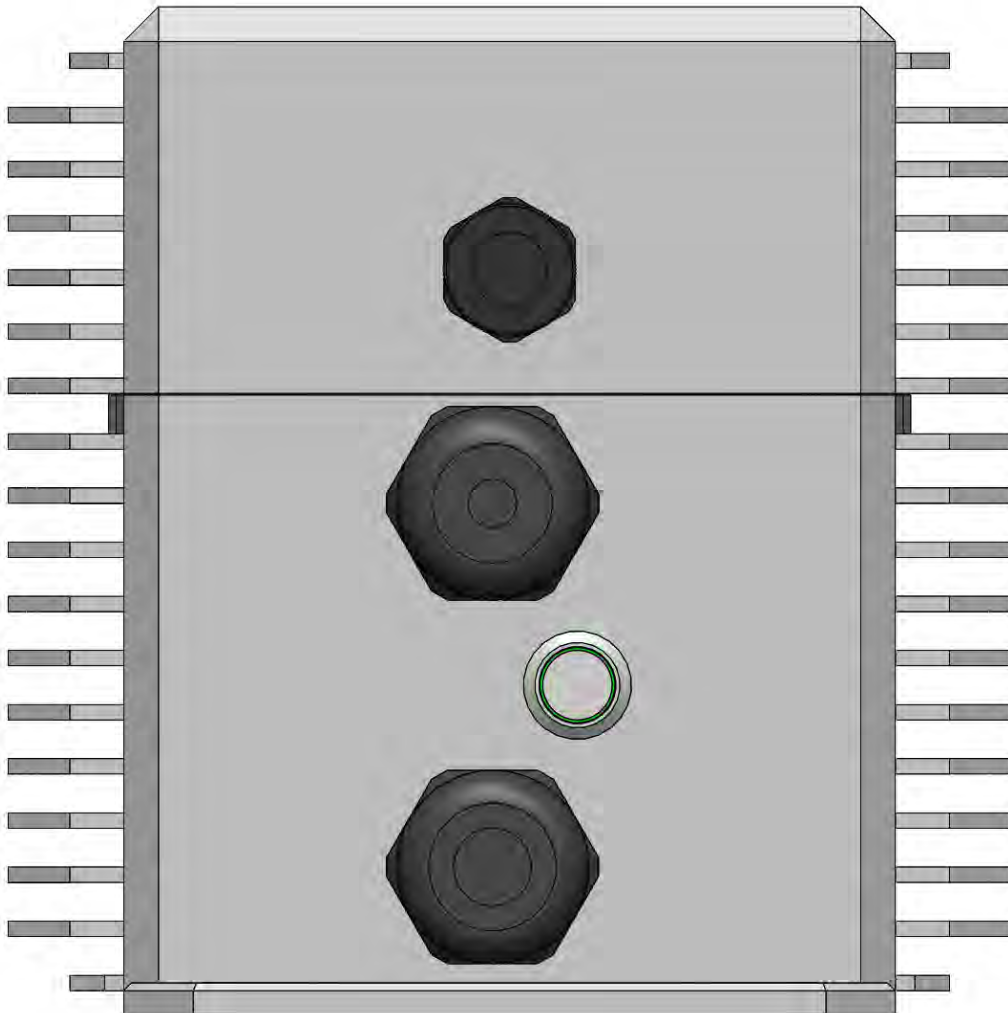

CONNECTING ORDER

1. DC OUTPUT (APPLICATION)
2. AC INPUT (SUPPLY NETWORK)

Dismantling order reverse to connection!



V_{IN}/V_{OUT} - ATTENTION!

1. Note correct colours and polarity!
2. Pay attention to the maximum cable length. The fixed input and output cables should not be lengthened because if the cables are too long, an unintentional power fail may be triggered (e.g. due to a voltage level change in the event of a load drop).

WIRING DIAGRAM

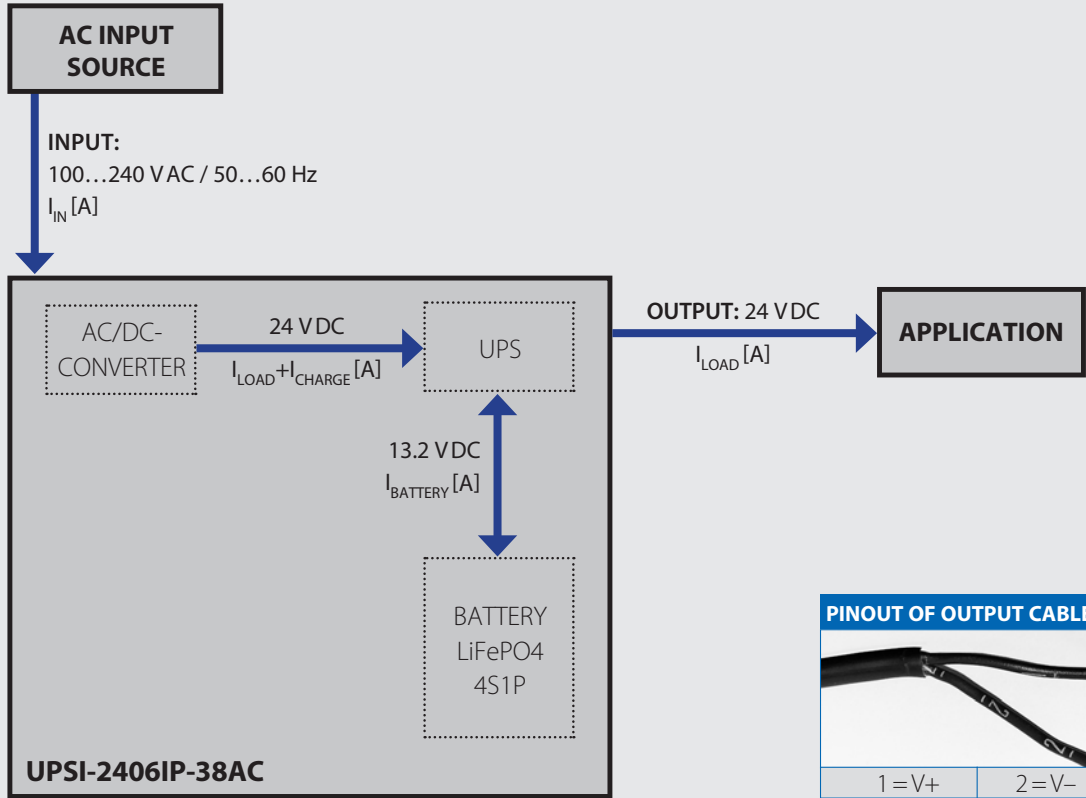

F5 Initial operation

The correct installation of the UPS has to be ensured.

The device starts as soon as it is connected to AC voltage (100...240 VAC nominal) via the AC input line. The voltage is converted internally to 24 VDC and passed on to the UPS module. The energy storage device is queried and transmits its data. The end-of-charge voltage is set and the memory is released. The charging process of the energy store then begins.

Reduced by a current-dependent voltage drop, the 24 VDC voltage is forwarded to the output. The device charges the energy storage and at the same time monitors the voltage thresholds/voltage values at the input (UPS function).

It must be ensured that the system or the power grid supplies enough power to guarantee normal operation (without charging) as well as charging („Dimensioning the upstream fuse“).

F6 Charging time

Charging time depends on operating temperature and load current

F7 Overcurrent / Short circuit / Overtemperature protection

Overcurrent:

If the load current at the output is too high, the device switches it off. For maximally allowed current values and peak current values refer to chapter D „Technical Data“. The status LED indicates the error status by means of a very rapid flashing sequence. A restart attempt occurs every 10 seconds in normal mode. During battery mode there is no restart attempt.

Short circuit:

In the event of a short-circuit at the output of the UPS, the output is immediately disconnected (<5ms). The status LED indicates the error status by means of a very rapid flashing sequence. A restart attempt occurs every second in normal mode (non-latch). During battery mode there is no restart attempt. The impact of a short-circuit to the device depends on length and diameter (impedance) of the output wiring. In case of a short-circuit directly at the device output a damage of the device can occur.

Overtemperature protection:

A temperature sensor is located on the AC/DC converter board, which checks the internal temperature. If this increases due to a defect, malfunction, incorrect use, etc., the overtemperature protection is triggered above a critical value and switches off the AC/DC converter until the value has dropped below a certain value (only in normal mode, not in battery mode!). The built-in battery is also monitored. The charging or discharging process is interrupted if the values are outside the specification.

F8 Backup time in battery mode

The nominal backup times can be found within the technical data of this user manual or the user manual of the used energy storages. At extreme low or high temperatures a reduction of the nominal backup times can occur.

F9 Behaviour in case of exceeding maximum backup time

When the given buffering times are exceeded, the output is separated on the basis of the SOC value or the discharge voltage of the corresponding energy storage (total discharge protection).

The lower the voltage of the energy storage device decreases, the higher the discharge current so that a constant power is ensured at the output of the UPS.

F10 Battery start

This function enables the application or the device to be started from the battery up to a max. load current of 6 A (SOC ≥10%) without the AC power supply being available/connected. To do this, the button on the bottom side of the device (connection side) must be pressed for longer than 2 seconds (max. 5 s).

F11 Dynamic Powerboost

Valid from firmware version 2.2.1

With the dynamic power boost function, it is possible to temporarily draw a higher output power (overload) from the UPS. As soon as an overload is detected when the threshold value is exceeded, this is possible in a dynamic overload range of up to 58 seconds, before the output is disconnected.

During operation, the device constantly measures the output energy drawn over the last 58 seconds (1 reading/second). This measured output energy is compared with the maximum possible output energy (max. 8.35 kJ). If the value is smaller, the device continues to run and the output remains unlocked. If the value is larger, the output is disconnected. The output energy will continue to be recorded and the output will not be released again until the value falls below the maximum value.

	UPSI-2406IP-38AC
Nominal output power ($I_{OUT\ Nominal} \times U_{OUT}$)	144 W
Threshold for detecting an overload	>144 W
Range for dynamic overload	144...192 W
Maximum output energy ($P_{OUT\ Nominal} \times t$)	~ 8.35 kJ (8352 Ws) (144 W x 58 sec)

Note: The output power is determined by output current and output voltage. A current-dependent voltage drop can reduce the output voltage, which is why the output power varies in some cases.

Example 1 (UPSI-2406DP1 / UPSI-2406DP2)

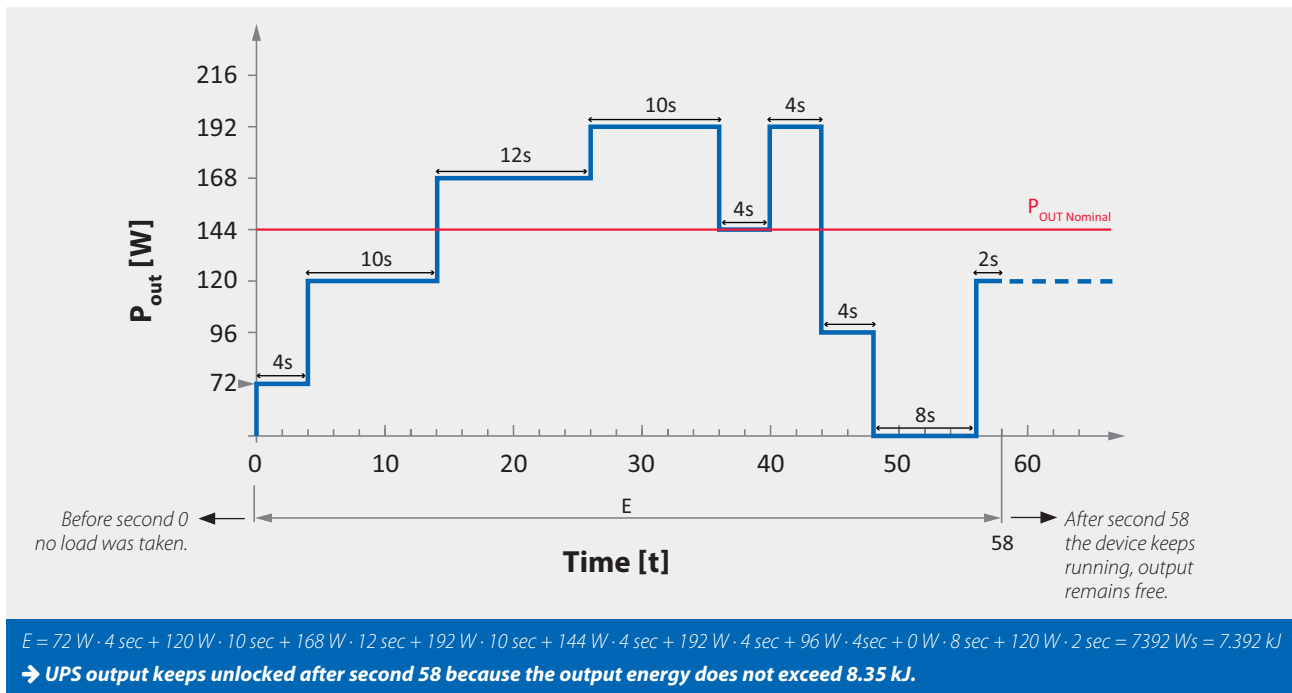

Example 2 (UPSI-2406DP1 / UPSI-2406DP2)

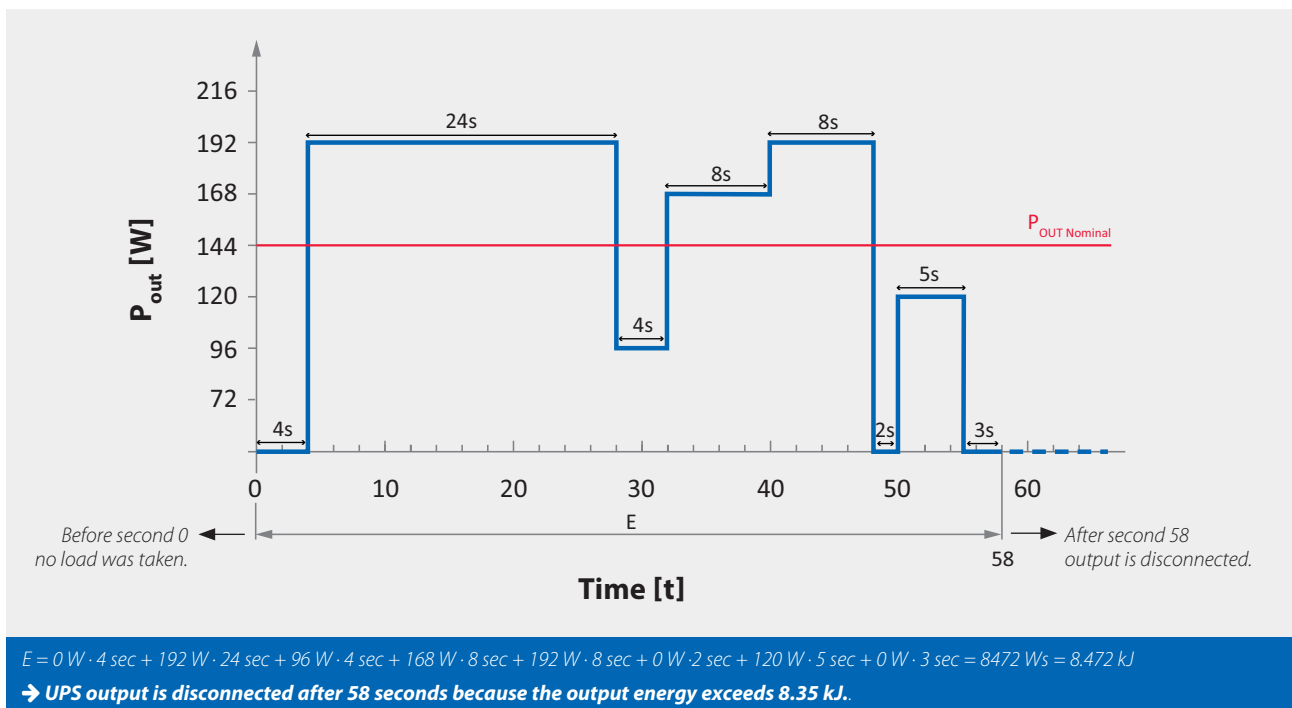

Example 3 (UPSI-2406DP3)

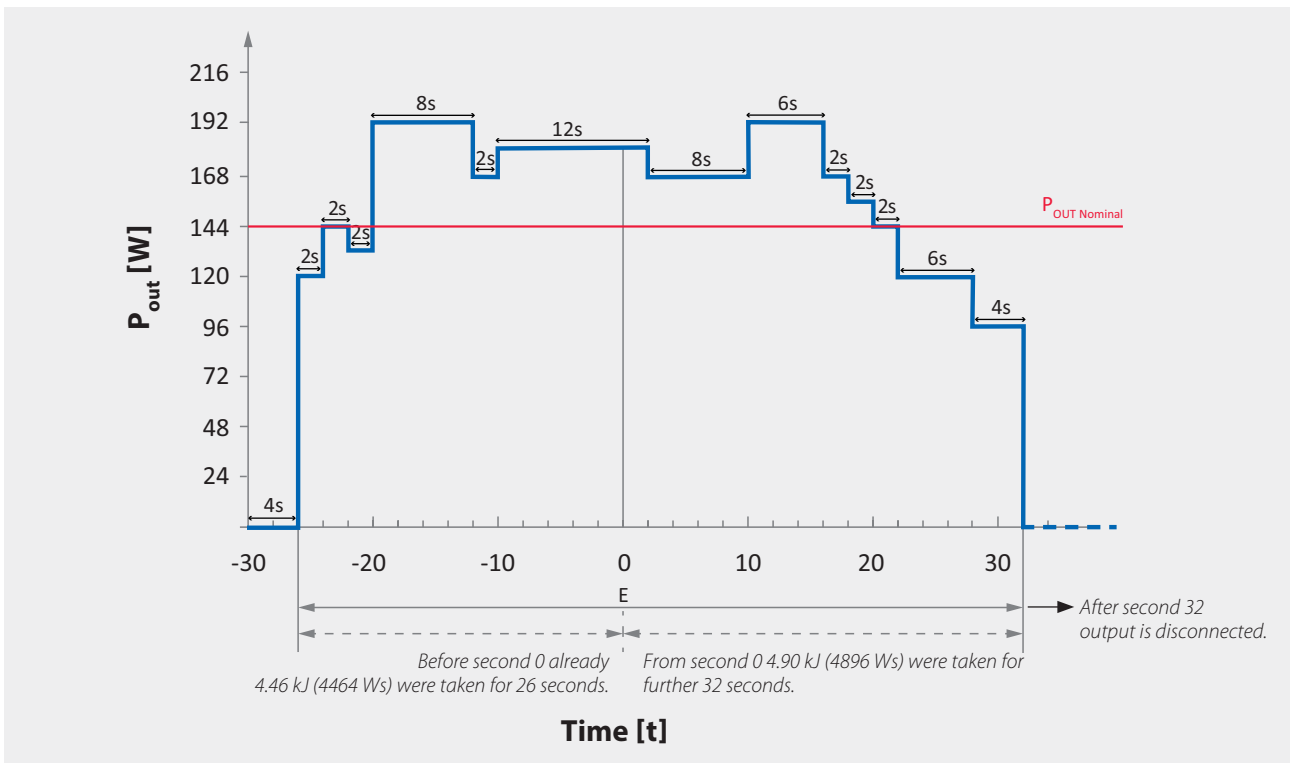







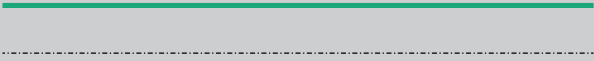

$E = 120\text{ W} \cdot 2\text{ sec} + 144\text{ W} \cdot 2\text{ sec} + 132\text{ W} \cdot 2\text{ sec} + 192\text{ W} \cdot 8\text{ sec} + 168\text{ W} \cdot 2\text{ sec} + 180\text{ W} \cdot 12\text{ sec} + 168\text{ W} \cdot 8\text{ sec} + 192\text{ W} \cdot 6\text{ sec} + 168\text{ W} \cdot 2\text{ sec} + 156\text{ W} \cdot 2\text{ sec} + 144\text{ W} \cdot 2\text{ sec} + 120\text{ W} \cdot 6\text{ sec} + 96\text{ W} \cdot 4\text{ sec} = 9360\text{ Ws} = 9.360\text{ kJ}$

→ UPS output is already disconnected after 32 seconds because the output energy (of the last 58 seconds) exceeds 8.35 kJ.

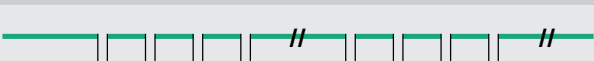
F12 Status LED

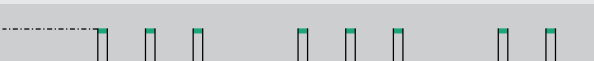
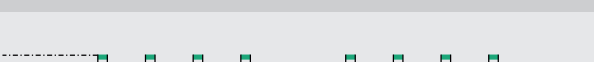
Valid from firmware version 2.1.19

MAIN STATES		
	Always on	Status: mains voltage >> Mains voltage is present.
	1 Hz flash (1 s on, 1 s off)	Status: Battery mode >> Mains voltage is not present.
INTERNAL STATES		
	1 x flash (LED is off briefly), pause 2 s	Status: Battery start >> Manual start from the battery by pressing the BS button.
	2 x flash (LED is off briefly), pause 2 s	Status: Capacity not reached* >> Capacity is required. Output is only activated when the battery is charged to set SOC.
	3 x flash (LED is off briefly), pause 2 s	Status: Shutdown* >> UPS has received a shutdown signal and is waiting until the set load sensor value has fallen below.
	4 x flash (LED is off briefly), pause 2 s	Status: Reboot* >> Output is deactivated and time until reboot runs (Reboot phase).
BATTERY FAILURES		
	1 x flash (LED is off a long time), pause 2 s	Status: No battery detected
	2 x flash (LED is off a long time), pause 2 s	Status: Battery overvoltage >> Charge voltage at battery is too high, battery is deactivated.
	3 x flash (LED is off a long time), pause 2 s	Status: Battery overcurrent >> Charge current at battery is too high, battery is deactivated.
	4 x flash (LED is off a long time), pause 2 s	Status: Battery temperature failure >> Battery temperature sensor was not detected or battery temperature is too high or low.
UPS FAILURES		
	Quick flashing without pause	Status: UPS failure >> Output current too low, UPS is deactivated. >> Overcurrent at output (load current too high), output is deactivated >> Short circuit at output, output is deactivated >> Internal failure, UPS is deactivated.

* Not available with UPSI-IP-3 series

F13 Shutdown diagram

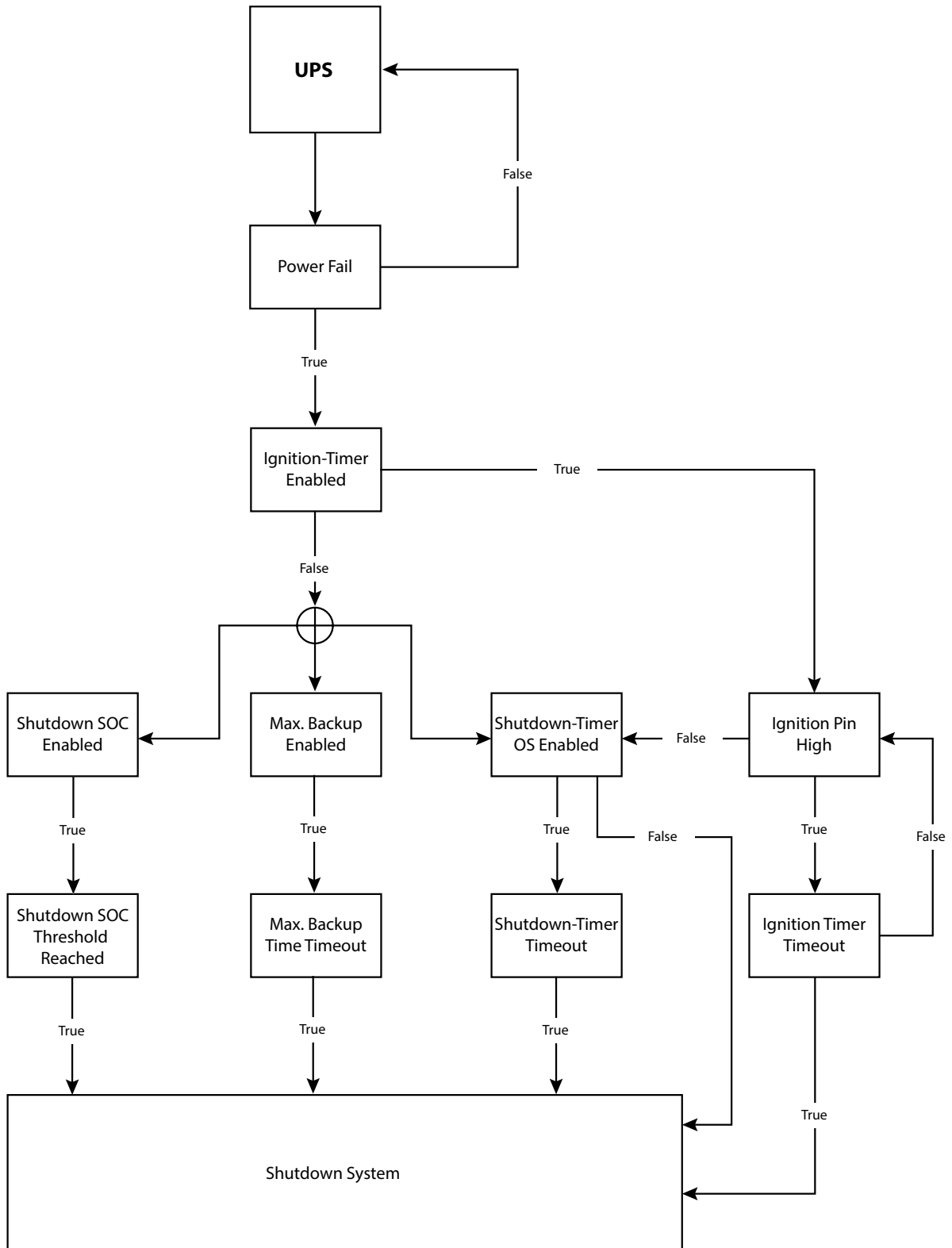

F14 Recommendations for a long UPS service life

LiFePO4 batteries age over time depending on cycles, operating temperature and the level of the end-of-charge voltage. The end-of-charge voltages are optimized so that they are at an optimum between service life and performance.

To extend the lifetime of the system, the device should not be placed near sources of heat and should be placed within good air-circulation. The less deep the packs are discharged, the longer the service life lasts.

F15 Maintenance

The UPS contains no serviceable parts. In case of a malfunction the upstream power source has to be disconnected and cables have to be removed. Use a dry cloth for cleaning! Maintenance and replacement of batteries has to be done by the manufacturer.

F16 Disposal

Electric and electronic devices must not be disposed with domestic waste!
Please consider to each country's own regulation about recycling and disposal of used batteries at the end of their lifetime or resending to any recycling organization.



F17 Disclaimer

We, the Bicker Elektronik GmbH, have checked the contents of this document for compliance with the hardware and software described. Nevertheless, deviations can not be ruled out, so we assume no liability for the complete agreement. The information in this publication is checked regularly, necessary corrections are included in the updated versions.

Suggestions for improvement as well as tips and criticism are always welcome.

F18 Scope of delivery

SCOPE OF DELIVERY	
QUANTITY	DESCRIPTION
1x device	UPSI-2406IP-38AC, incl. already permanently installed input and output cable
1x	V _{IN} cable, 3x 1.5 mm ² (inclusive PE), length 3 m, open end
1x	V _{OUT} cable, 2x 1.5 mm ² , length 3 m, open end

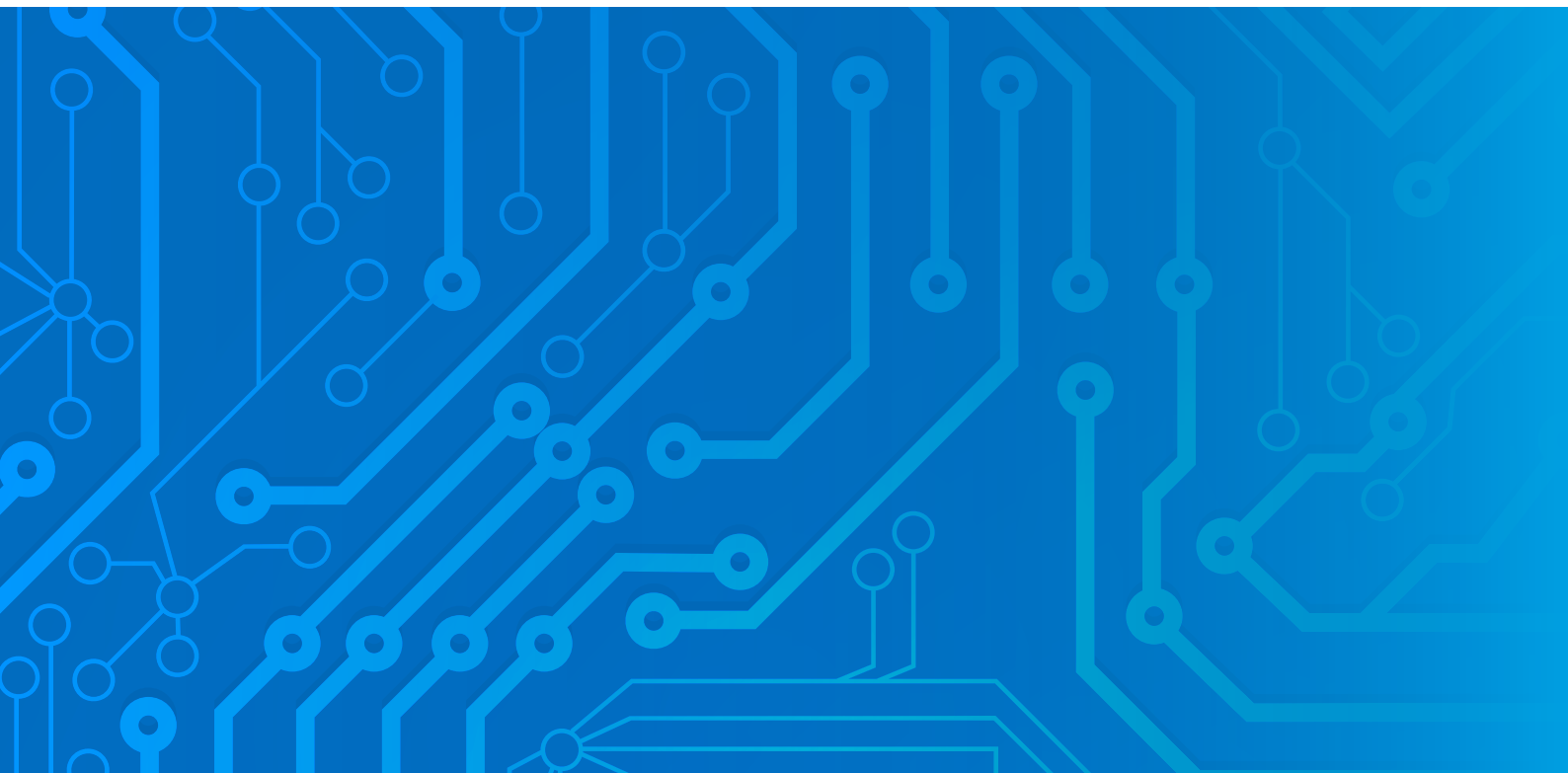

Note: Subject to errors and technical modifications!
Windows® is a registered trademark of the Microsoft Corp.
Status as at: 21.09.2022 – Revision 1-0



Bicker Elektronik GmbH
Ludwig-Auer-Straße 23
86609 Donauwörth · Germany
Tel. +49 (0) 906 70595-0
Fax +49 (0) 906 70595-55
E-Mail info@bicker.de
www.bicker.de