

**ROLLON**<sup>®</sup>  
BY TIMKEN

*Light Rail*

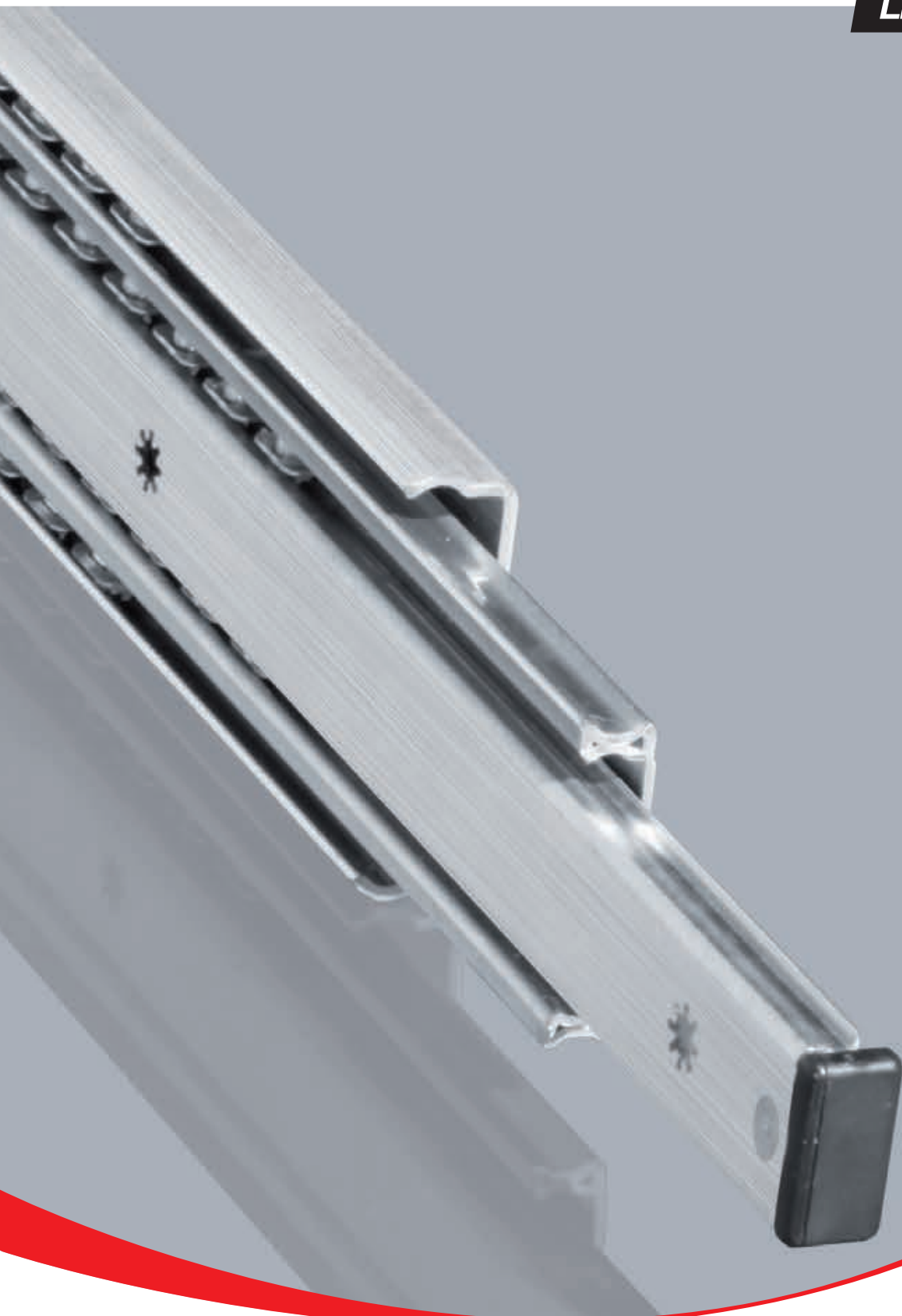

## > Light Rail



### 1 Product explanation

Light telescopic rails, with full or partial extension

LR-2

### 2 Product cross sections

LR-4

### 3 Technical data

Performance characteristics and notes

LR-5

### 4 Dimensions and load capacity

LPS

LR-6

LFS

LR-7

LFS

LR-8

LFS SC

LR-9

LFS

LR-10

LFX

LR-11

DRX/DRS,

Fixing screws

LR-12

### 5 Technical instructions

Load capacities

LR-13

Speed, Temperature, Lubrication, Corrosion protection

LR-14

Installation instructions, DRX/DRS installation

LR-15

### Ordering key













Ordering key with explanations

LR-16

### Guides suitable for all applications

# Technical features overview



Reference			Product name	Extraction	Size	Profile		Self alignment	Slider		Steel	
Product Family	Product	Section				Type	Hardened raceways		Balls	Rollers		
Light Rail		LPS		LPS38	 50%	38	Formed Sheetmetal		++	■	■	■
		LFS		LFS46	 100%	46	Formed Sheetmetal		++	■	■	■
				LFS57		57						
				LFS58		58						
				LFS70		70						
		LFX		LFX27	 100%	27	Formed Sheetmetal		++	■	■	■
		DRX/DRS		DRS30	 100%	30	Formed Sheetmetal		++	■	■	■
DRX30				30								

Reported data must be verified according to the application.

\* The maximum value is defined by the application. For more information, please contact our technical department.

■ standard

X steel

A stainless steel

aluminum

B stroke in both directions

BM stroke in both directions

with driving disc

Material		Stroke direction		Snap closed position	Locking	Damping closed position	Max. load capacity per pair [N]		Max. rail length [mm]	Max. stroke [mm]	Max. extension speed* [m/s]	Rigidity (deflection)	Operating temperature [°C]
X	A	B	BM				C <sub>Orad</sub>	C <sub>Oax</sub>					
							350	100	473	373	0,5	+	+10 °C/+40 °C
						■	400	100	600	610	0,5	+	+10 °C/+40 °C
						■	800	160	750	800			
						■	600	-	550	584			
				■		■	2000	300	1100	1100			
	■						350	50	550	576	0,5	+	-30 °C/+200 °C
							720	-	1040	1120	0,5	+	-20°C /+100°C
	■					■	720	-	1040	1120			

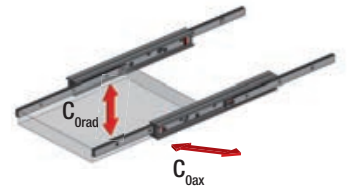

## Product explanation



### > Light telescopic rails, with full or partial extension



Fig. 1

The Light Rail product family consists of five series with full and partial extensions in a lightweight design. It is ideal for applications in which the mass of the rail is just as important as the bending rigidity.

#### The most important characteristics:

- Light and quiet running with heavy loads
- Long service life without maintenance
- Effective self-cleaning of the ball track
- High functional reliability
- Structural elasticity capable of absorbing minor impacts and absence of permanent deformation
- Not sensitive to side impacts

#### Preferred areas of application:

- Beverage industry
- Automotive
- Construction and machine technology (e.g., housing)
- Packaging machines
- Railcars (e. g., maintenance and battery extensions)
- Special machines

**LPS 38**

Partial extension with rails made of hot-dipped galvanized steel and plastic ball cages.



Fig. 2

**LFS 46**

Detachable internal rail which can be released with a latch. Rails are made of bright chrome-plated steel, the ball cages of steel and plastic. Roll back protection in closed position.



Fig. 3

**LFS 57**

Full extension with rails made of hot-dipped galvanized steel and zinc-plated steel ball cages. Roll back protection in closed position.



Fig. 4

**LFS 58 SC**

Full extension with automatic retraction and damping. The automatic retraction system is assisted by a spring-loaded mechanism that allows the rail to get back to a complete retraction before reaching the closed position.



Fig. 5

**LFS 70**

Full extension with rails made of zinc-plated galvanized and blue passivated steel. The ball cages are made of zinc-plated steel. Heavy load end stop in opened and closed position. Roll back protection in closed position.



Fig. 6

**LFX 27**

The stainless steel full extension consists of two inner guide rails that, connected to a double-T profile, form the intermediate element and two outer rails that form the connection to the connecting construction as fixed and moving element. The square cross-section allows a compact design of high load ratings and low deflection.



Fig. 7

**DRX-DRS**

Roller type telescopic rail made of stainless or galvanized steel. Corrosion resistant even if scratched, exposed to solvents or to shocks.



Fig. 8

# Overview product cross sections



## > Partial extension guides

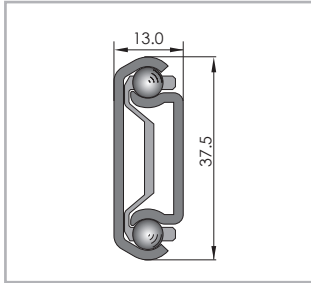

Fig. 9

**LPS38**

Load capacities p. LR-6

## > Full extension guides

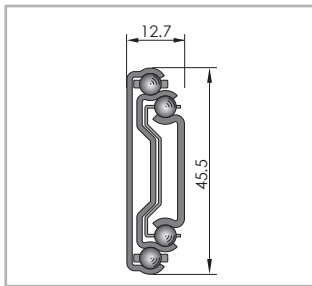

Fig. 10

**LFS46**

Load capacities p. LR-7

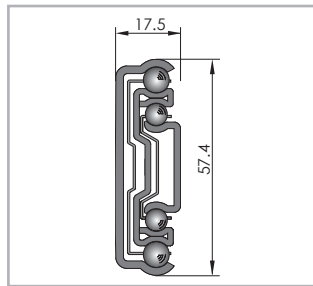

Fig. 11

**LFS57**

Load capacities p. LR-8

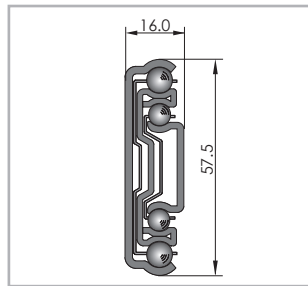

Fig. 12

**LFS58 SC**

Load capacities p. LR-9

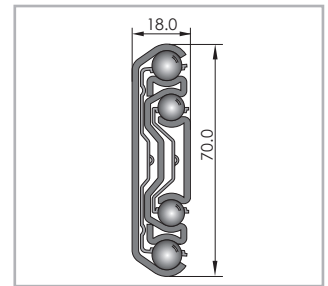

Fig. 13

**LFS70**

Load capacities p. LR-10

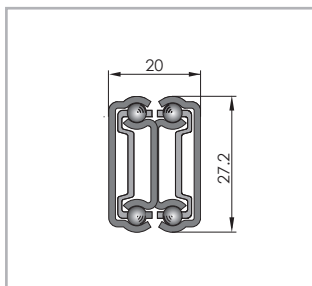

Fig. 14

**LFX27**

Load capacities p. LR-11

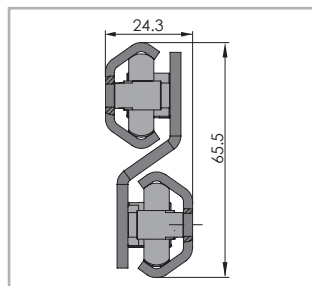

Fig. 15

**DRX/DRS30**

Load capacities p. LR-12

## Technical data

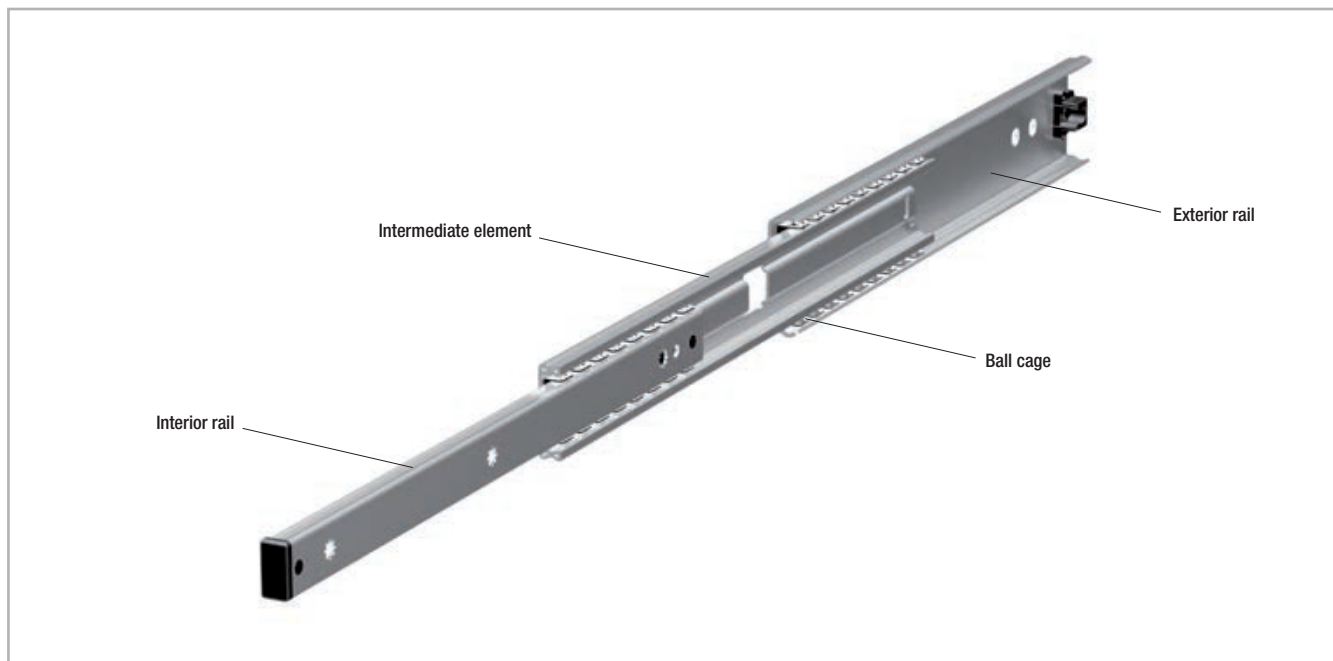

Fig. 16

### Performance characteristics:

- Extension speed (depending on application):
  - Extension distance 100 - 500 mm: max. 0.5 m/s (19.69 in/s)
  - Extension distance 600 mm: max. 0.4 m/s (15.75 in/s)
  - Extension distance 700 mm: max. 0.3 m/s (11.81 in/s)
- LFS 58 SC series with automatic retraction
- Temperature range: from +10 °C to +40 °C, for DRX/DRS from -20° to + 100° C, for LFX from -30° to +200° C.
- Temporary storage and transport temperature: -20 °C to max. +80 °C (-4 °F to +176 °F)
- All systems are lubricated for life
- LFS/LPS rail material: hot galvanized or chromed steel
- LFS/LPS ball bearing cage material: galvanized steel or plastic
- LFS/LPS ball bearing material: hardened carbon steel
- LFX rail, balls and cage material: stainless steel 1.4301
- DRX rail material: stainless steel AISI 316L
- DRS rail material: galvanized steel ISO 2081 compliant

### Remarks:

- All load capacity data are based on a pair of telescopic rails
- Horizontal movement installation is recommended
- Vertical movement installation on request
- Assembly in cross-sectional width, here a positive tolerance of +0.5 mm is recommended (mounted under tension). If the extensions are installed with too small a tolerance, the service life is decreased
- Cycle data applies to the use of an extension pair (recommended)
- Vertical use of extensions (radial load) is recommended
- If mounted in a horizontal position, the load capacity will be reduced (see p. LR-13 )
- Cathodic edge protection, additional corrosion protection with powder coating on request
- Roll back protection in closed position is friction locked (except LPS 38)
- Not suitable for moments – must be used as extension pair



# Dimensions and load capacity



> LPS 38

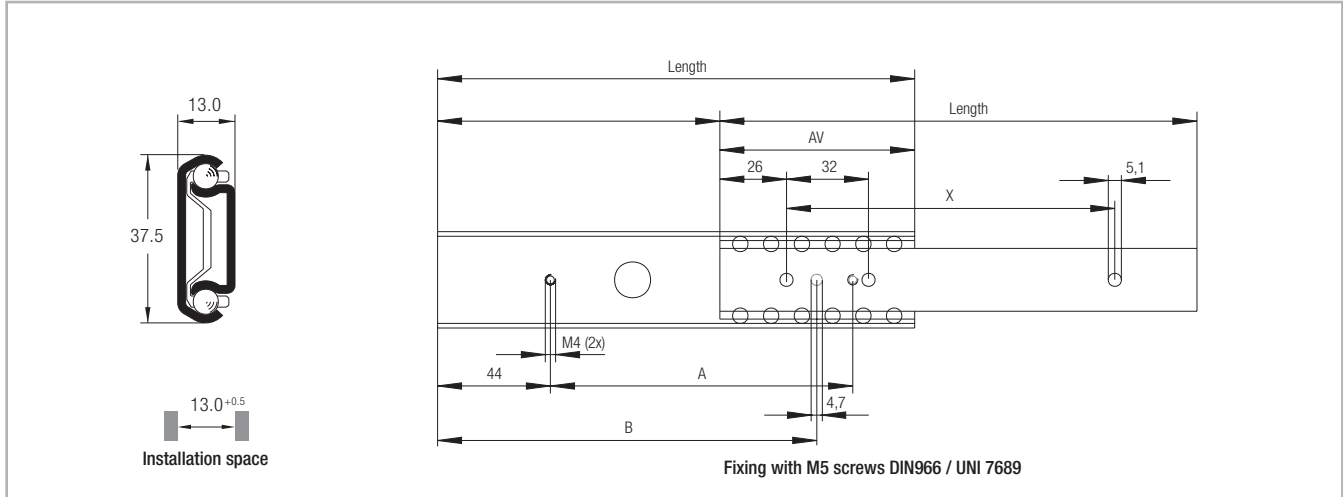

All dimensions given in mm

Fig. 17

Type	Size	Length [mm]	Extension loss AV [mm]	Stroke* [mm]	A [mm]	B [mm]	X [mm]	Load capacity for a pair of rails		Weight per single guide [kg]
								$C_{0rad}$ [N]	$C_{0ax}$ [N]	
LPS	38	242	88	154	166	202	192	350	100	0.30
		317		229	241	277	256			0.40
		398	100	298	322	358	352			0.50
		473		373	397	433	416			0.60

\* The stroke is the difference of the length and the extension loss AV

Tab. 1

Note: The given load capacities are guidelines with 100,000 cycles and uniform load distribution (area load) when using all mounting holes. The load values must be reduced in unfavorable conditions.

> LFS 46

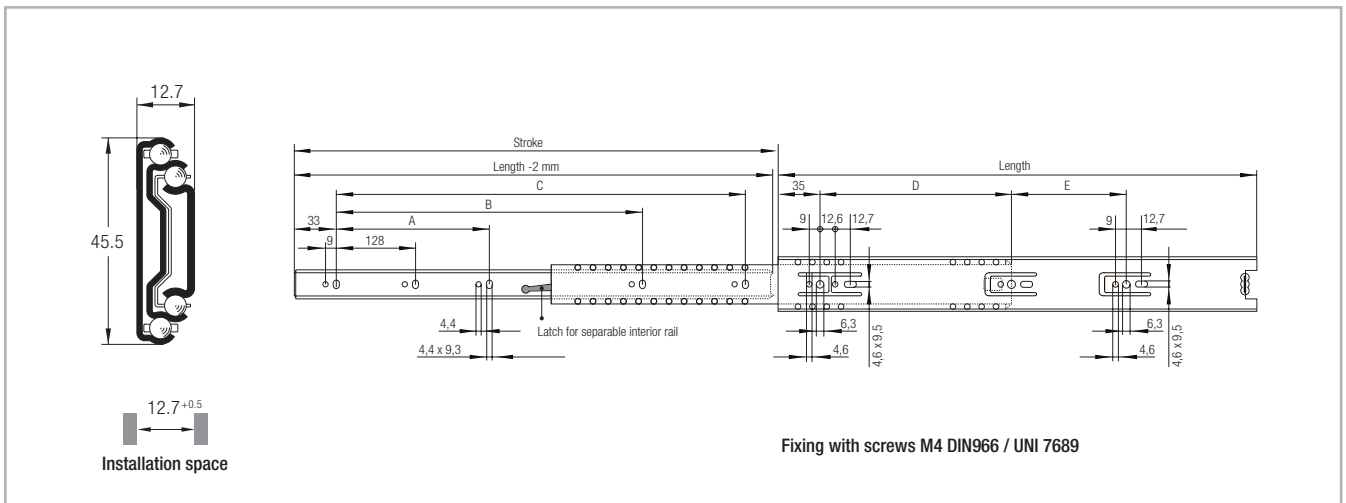

All dimensions given in mm

Fig. 18

Type	Size	Length	Stroke	A	B	C	D	E	Load capacity for a pair of rails	Load capacity for a pair of rails	Weight per single guide
		[mm]	[mm]	[mm]	[mm]	[mm]	[mm]	[mm]	$C_{Orad}$ [N]	$C_{Oax}$ [N]	[kg]
LFS	46	300	305	-	-	242	192	-	300	100	0,48
		350	356	-	-	292	256	-	300		0,505
		400	406	-	256	342	160	96	350		0,64
		450	457	-		392		160			0,71
		500	508	-	352	442	224	128	400		0,79
		550	559	224	416	492		192			0,88
		600	610			542		224			0,95

Tab. 2

Note: The given load capacities are guidelines with 50,000 cycles and uniform load distribution (area load) when using all mounting holes. The load values must be reduced in unfavorable conditions.

> LFS 57

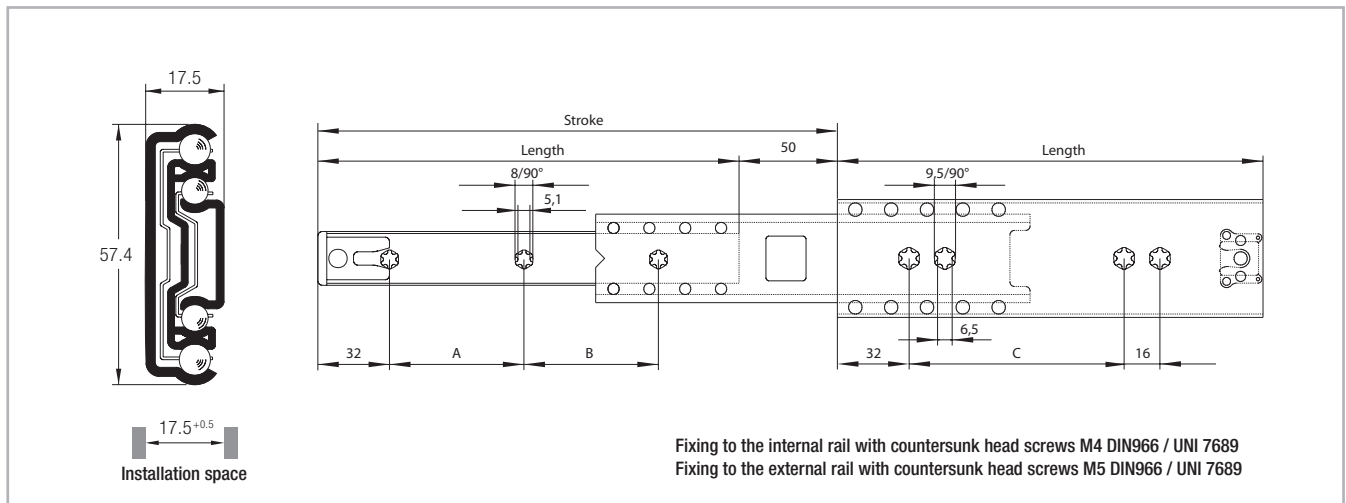

All dimensions given in mm

Fig. 19

Type	Size	Length	Stroke*	A	B	C	Load capacity for	Load capacity for	Weight per
		[mm]	[mm]				[mm]	[mm]	
							$C_{0rad}$	$C_{0ax}$	
							[N]	[N]	[kg]
LFS	57	300	350	128	104	160	500	160	0.84
		350	400		152		600		0.98
		400	450	160	168	256	650		1.13
		450	500		224		700		1.27
		500	550	224	208	384	750		1.42
		550	600		256		1.57		
		600	650	288	240	800	800		1.71
		650	700		288		1.86		
		700	750	320	312	2.01			
		750	800		360	2.16			

\* The stroke is the sum of the length and the over extension

Tab. 3

Note: The given load capacities are guidelines with 100,000 cycles and uniform load distribution (area load) when using all mounting holes. The load values must be reduced in unfavorable conditions.

> LFS 58 SC

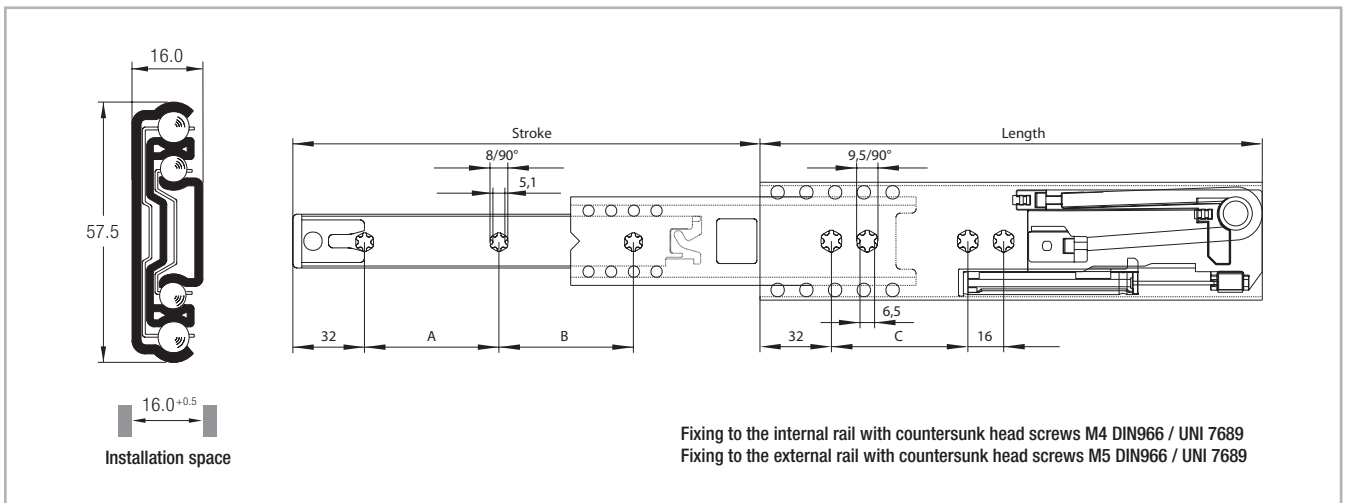

All dimensions given in mm

Fig. 20

Type	Size	Length	Stroke	A	B	C	Load capacity for a pair of rails	Weight per single guide
		[mm]	[mm]	[mm]	[mm]	[mm]	$C_{Orad}$ [N]	[kg]
LFS	58	400	434	128	128	224	400	1.10
		450	484	160	160	256	500	1.25
		500	534			320	550	1.40
		550	584	192	600		1.55	

Tab. 4

Note: The given load capacities are guidelines with 100,000 cycles and uniform load distribution (area load) when using all mounting holes. The load values must be reduced in unfavorable conditions. Horizontal installation is not possible due to the damping system. The damping effect is reduced for loads of 450 N and higher per extension pair.

> LFS 70

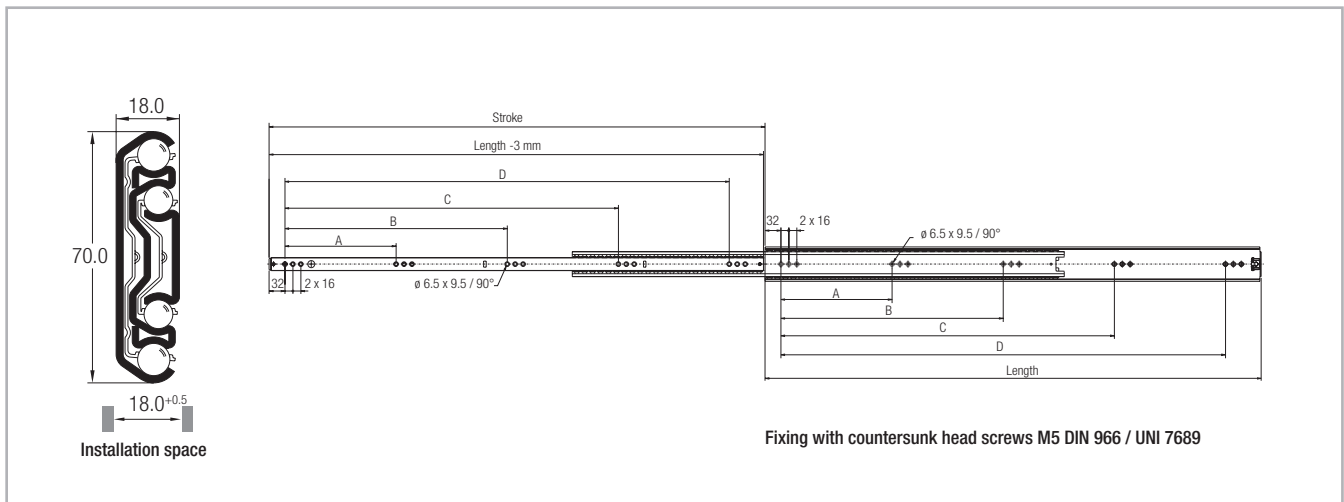

All dimensions given in mm

Fig. 21

Type	Size	Length	Stroke	A	B	C	D	Load capacity for a pair of rails		Weight per single guide	
		[mm]	[mm]	[mm]	[mm]	[mm]	[mm]	$C_{Orad}$ [N]	$C_{Oax}$ [N]		
LFS	70	400	400	-	-	-	288	1050	1800*	300	1,55
		450	450	-	-	160	320	1150	1900*		1,74
		500	500	-	-	192	384	1300	1950*		1,94
		550	550	-	-	224	448		2000*		2,13
		600	600	-	-		1950*		2,32		
		700	700	-	192	384	576	1750*	2,70		
		800	800	-	224	448	672	1200	1450*		3,10
		1100	1100	224	448	672	896	900	1050*	200	4,25

\* 10.000 cycles

Tab. 5

Note: The given load capacities are guidelines with 100.000 cycles and uniform load distribution (area load) when using all mounting holes. The load values must be reduced in unfavorable conditions.

> LFX 27

Stainless steel telescopic guide

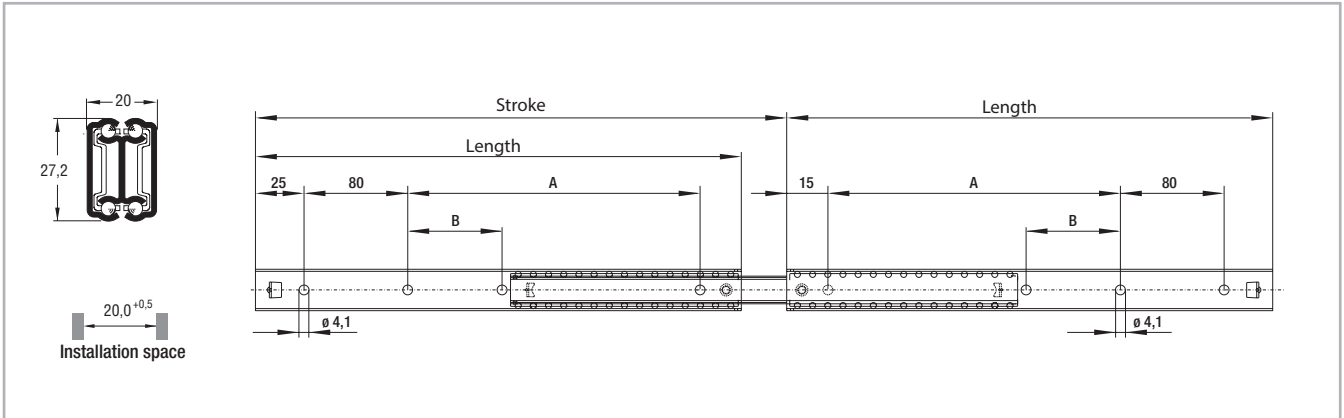

Fig. 22

Type	Size	Length [mm]	Stroke [mm]	A [mm]	B [mm]	Load capacity for a pair of rails [N]				Weight per single guide [kg]
						to 10.000 cycles		to 100.000 cycles		
						$C_{Orad}$	$C_{Oax}$	$C_{Orad}$	$C_{Oax}$	
LFX	27	300	326	180	-	350	50	250	50	0,43
		350	376	230	70					0,49
		400	426	280	100					0,57
		450	476	330	100					0,64
		500	526	380	140					0,72
		550	576	430	160					0,76

Tab. 6

> DRX/DRS

DRX version in stainless steel

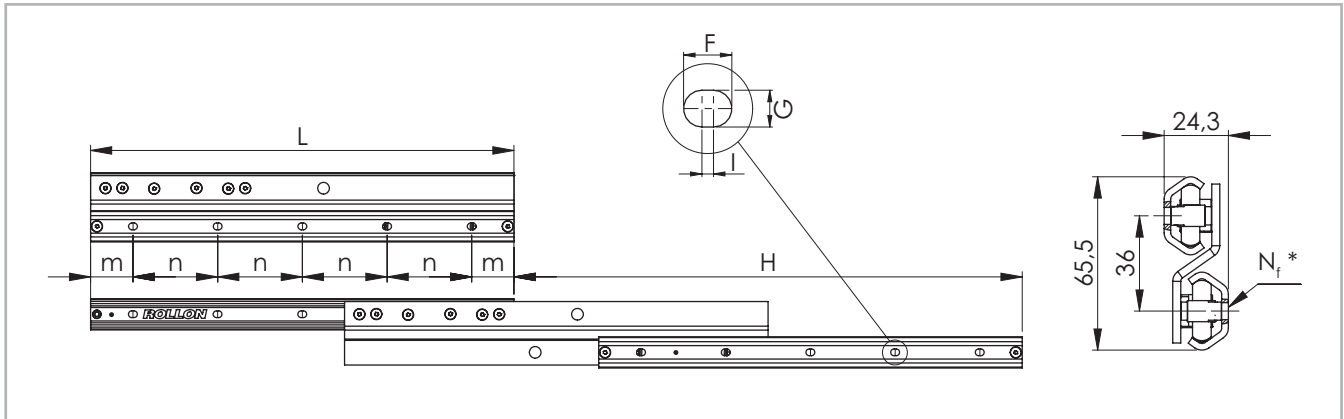

\* Number of mounting holes

Fig. 23

Type	Size	Length L [mm]	Stroke H [mm]	Load capacity for a pair of rails $C_{0rad}$ [N]	Fixed and movable rail							
					m [mm]	n [mm]	$N_f$ [2 rails]	Holes for screws	Weight per single guide [kg/m]	F [mm]	G [mm]	I [mm]
DRX DRS	30	400	480	300	40	80	10	M5	3.40	8,4	6,4	2
		480	560	400			12					
		560	640	480			14					
		640	720	560			16					
		720	800	640			18					
		800	880	720			20					
		880	960	700			22					
		960	1040	620			24					
		1040	1120	500			26					

Tab. 7

> Fixing screws

We recommend fixing screws according to ISO 7380 with low head height or TORX® screws (see fig. 24) on request.

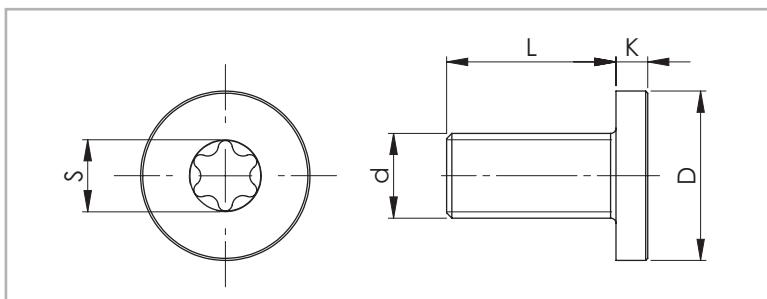

Fig. 24

Rail size	Screw type	d	D [mm]	L [mm]	K [mm]	S	Tightening torque [Nm]
30	M5 x 10	M5 x 0.8	10	10	2	T25	9

Tab. 8

# Technical instructions

## > Load capacities

### Vertical installation (radial load)

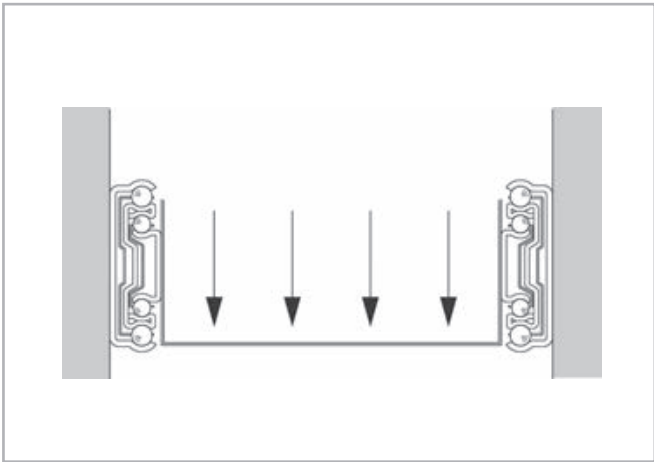

Fig. 25

The given loading capacities are guidelines for a pair of rails vertically mounted with uniform load distribution using all mounting holes. The load values must be reduced in unfavorable conditions.

### Horizontal installation (axial load)

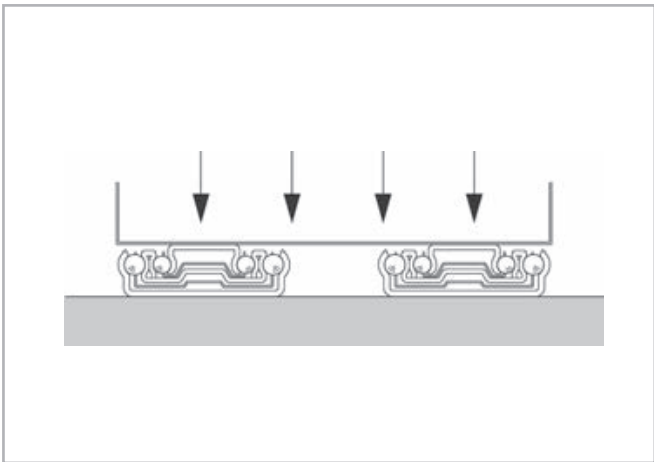

Fig. 26

For horizontal mounted extensions the load capacity is reduced (see pg. LR-6ff).  
The DRS/DRX series is not suitable for use on horizontal mounting (axial loads)



## > Speed

The extension speed is determined by the size of the intermediate elements. Therefore, the maximum extension speed is inversely proportional to the overall extension of the rails (see fig. 27). The maximum extension speed is also directly related to the applied load and operating time. The indicated data refers to continuous operation at the maximum load capacity.

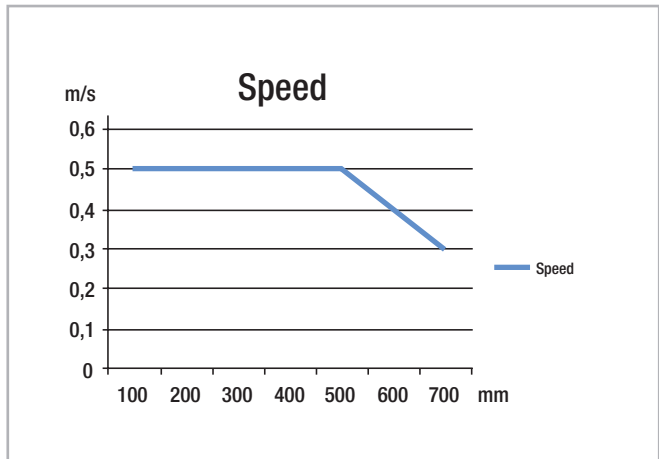

Fig. 27

## > Temperature

Continual operating temperature of the Light Rail extensions is +10 °C to +40 °C. Temporary storage and transport temperature: -20 °C to max. +80 °C. The operating temperature for the DRX/DRS rails ranges from -20 °C to +100 °C. For more information please contact Rollon technical support.

## > Lubrication

All extensions of the Light Rail product family are lubricated for life. Different lubricants for special applications are available upon request. Example: Lubricant with FDA approval for use in the food industry. For more information please contact Rollon technical support.

## > Corrosion protection

Base material for the Light Rail product family is cold-rolled, hot-dipped galvanized steel. The cathodic edge protection offers a perfect combination of quality and cost-efficiency. The surface protection conforms to RoHS. The DRX/DRS series rails are also available in the stainless steel version for a high corrosion resistance. For more information please contact Rollon technical support.

## > Installation instructions

- The existing internal stops are not designed to stop the moving load. They are only supposed to retain the ball-cage and prevent the internal parts to slide out of the assembly. An external end-stop must always be installed to stop the moving load.
- To achieve optimum running properties, high service life and rigidity, it is necessary to fix the Light Rail extensions with all accessible holes on a rigid and level surface. Please observe the parallelism of the installation surfaces. The fixed and movable rails fit to the rigid assembly construction.
- Light Rail full and partial extensions are suitable for use in automatic systems. For this, the stroke should remain constant in all moving cycles and the extension speed must be checked (see pg. LR-14, fig.27). The movement of the extensions is enabled by internal ball cages, which could experience an offset from the original position with differing strokes. This phase offset can have a negative effect on the running properties or limit the stroke. If differing strokes occur in an application, the drive force must be sufficiently dimensioned in order to appropriately synchronize the ball cage offset. As an alternative, an extra full stroke cycle can be performed every certain number of cycles, in order to re-phase the ball cage in its correct position.

### Horizontally installed guides

Horizontally installed extensions can support tension or compression loads (see figs. 28 and 29).

For the horizontal mounting of extensions with compression loads, please take the following conditions into account: The Hertzian stress of the balls is no longer effective due to the expansion of the rail profile; the nominal tension tolerance of +0.5 mm is eliminated due to the installation confi-

guration. Both the above mentioned conditions contribute to a significant reduction of the axial load capacity.

Horizontally-mounted rails (axial load) also determine a considerably higher deflection of the extended tips if compared to traditionally vertically-mounted rails (radial load).

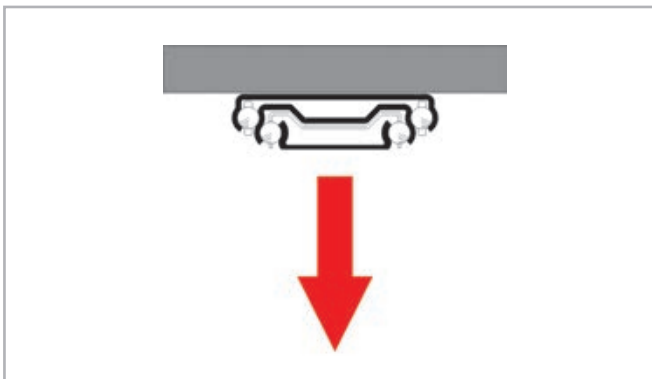

Fig. 28

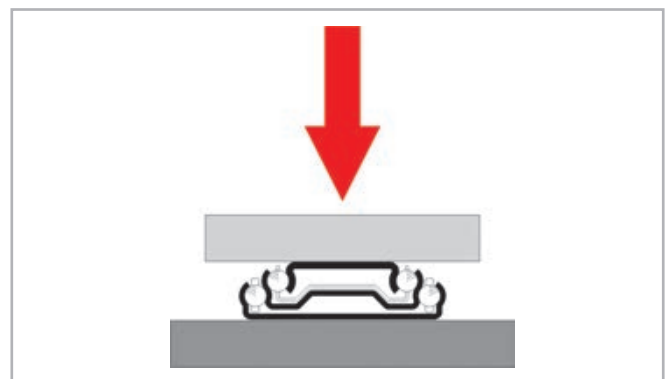

Fig. 29

## > DRX/DRS installation

- During installation care must be taken that the movable elements are assembled as in the figure; i.e. as the lower rail. The opposite upside-down assembly negatively affects the function.
- Internal stops are used to stop the unloaded slider and the ball cage. Please use external stops as end stops for a loaded system.
- To achieve optimum running properties, high service life and rigidity, it is necessary to fix the telescopic rails with all accessible holes on a rigid and level surface.
- Please observe the parallelism of the installation surfaces. The fixed and movable rails fit to the rigid assembly construction.

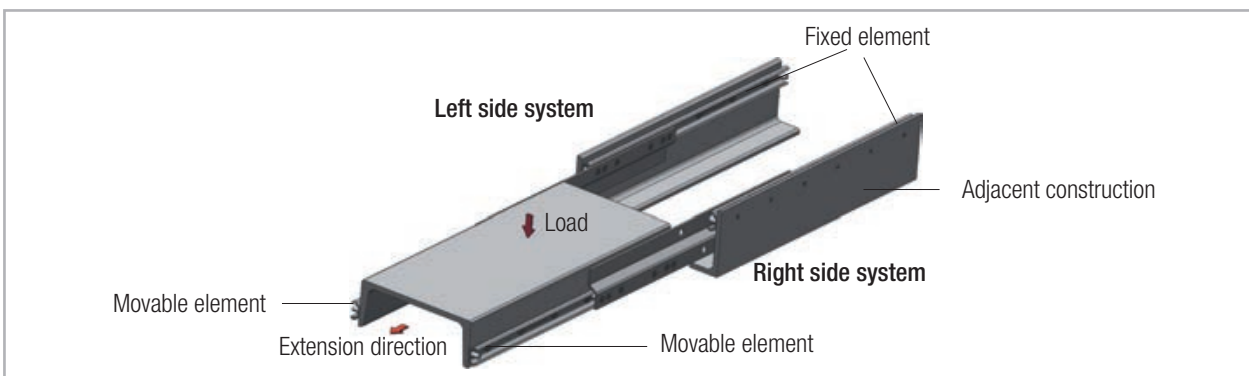

Fig. 30

# Ordering key

## > Light Rail

LFS	58-	400	SC	
			Automatic retraction only in LFS 58 SC	<i>see pg. LR-9</i>
		Rail length in mm	<i>see pg. LR-6</i>	
	Size	<i>see pg. LR-6</i>		
Rail type	<i>see pg. LR-6</i>			

Ordering example: LFS58-0400SC

Notes on ordering: The rail lengths are always indicated as 4 digits with 0 prefixes

Guides suitable for all applications



### Railway

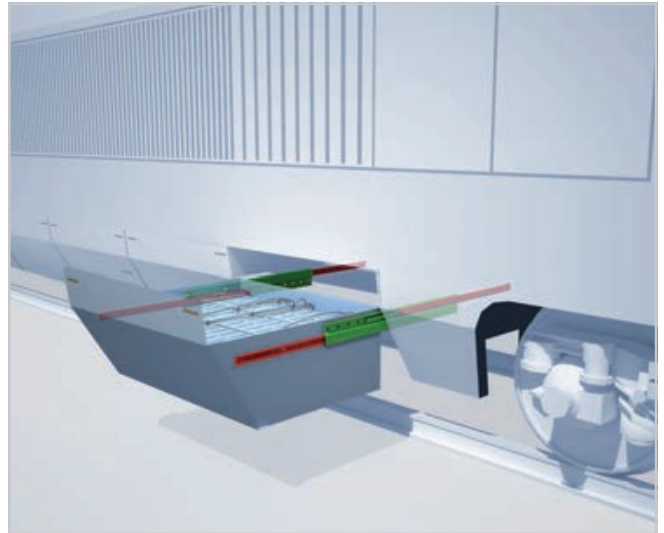
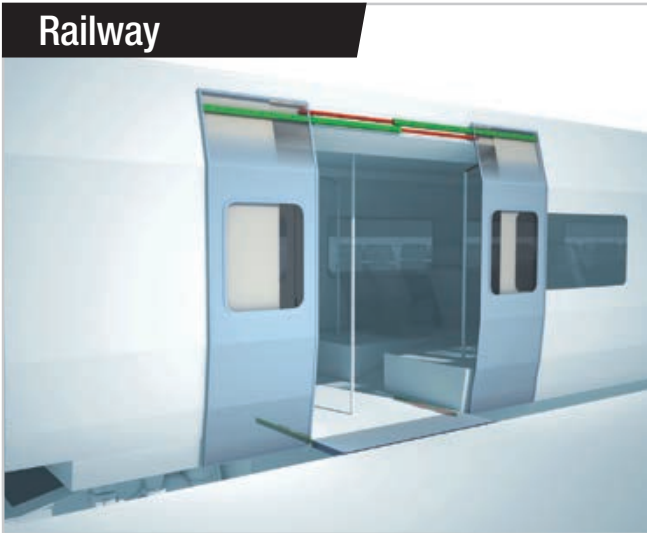

### Medical

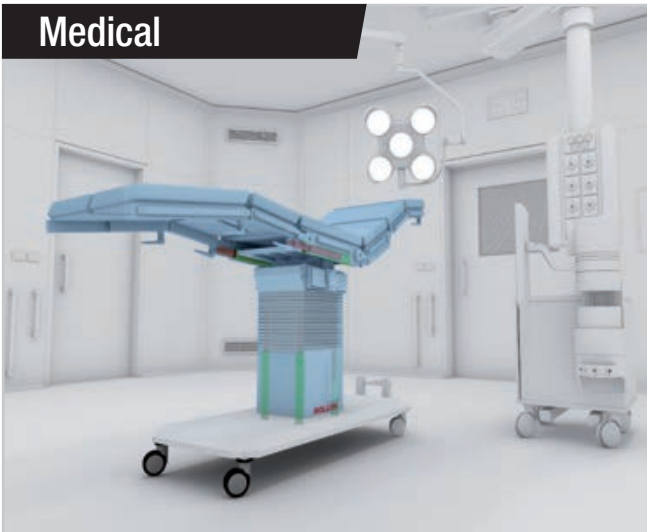

### Logistics

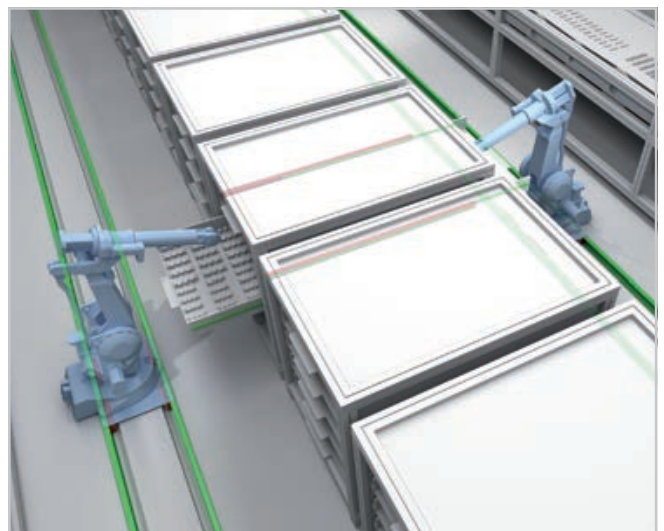

## Aerospace



## Special Vehicles



## Industrial

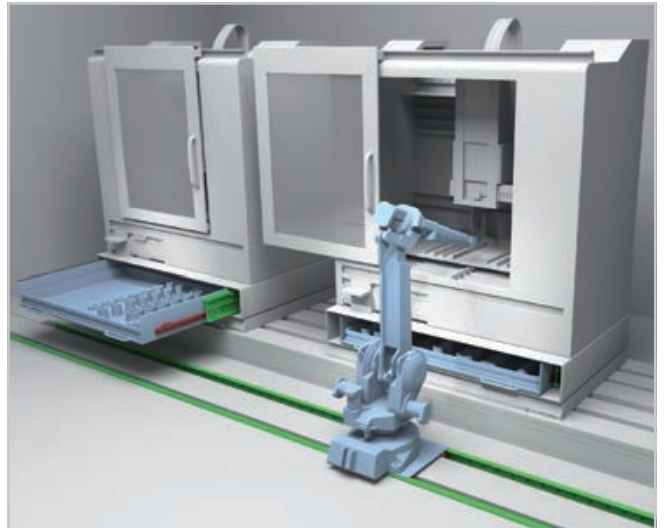



● Rollon Branches & Rep. Offices  
● Distributors

## EUROPE

### ROLLON S.p.A. - ITALY (Headquarters)

Via Trieste 26  
I-20871 Vimercate (MB)  
Phone: (+39) 039 62 59 1  
www.rollon.it - infocom@rollon.it

### ROLLON GmbH - GERMANY

Bonner Strasse 317-319  
D-40589 Düsseldorf  
Phone: (+49) 211 95 747 0  
www.rollon.de - info@rollon.de

### ROLLON S.A.R.L. - FRANCE

Les Jardins d'Eole, 2 allée des Séquoias  
F-69760 Limonest  
Phone: (+33) (0) 4 74 71 93 30  
www.rollon.fr - infocom@rollon.fr

### ROLLON B.V. - NETHERLANDS

Ringbaan Zuid 8  
6905 DB Zevenaar  
Phone: (+31) 316 581 999  
www.rollon.nl - info@rollon.nl

### ROLLON S.p.A. - RUSSIA (Rep. Office)

117105, Moscow, Varshavskoye  
shosse 17, building 1  
Phone: +7 (495) 508-10-70  
www.rollon.ru - info@rollon.ru

### ROLLON Ltd - UK (Rep. Office)

The Works 6 West Street Olney  
Buckinghamshire, United Kingdom, MK46 5 HR  
Phone: +44 (0) 1234964024  
www.rollon.uk.com - info@rollon.uk.com

## AMERICA

### ROLLON Corporation - USA

101 Bilby Road. Suite B  
Hackettstown, NJ 07840  
Phone: (+1) 973 300 5492  
www.rolloncorp.com - info@rolloncorp.com

### ROLLON - SOUTH AMERICA (Rep. Office)

R. Joaquim Floriano, 397, 2o. andar  
Itaim Bibi - 04534-011, São Paulo, BRASIL  
Phone: +55 (11) 3198 3645  
www.rollonbrasil.com.br - info@rollonbrasil.com

## ASIA

### ROLLON Ltd - CHINA

No. 1155 Pang Jin Road,  
China, Suzhou, 215200  
Phone: +86 0512 6392 1625  
www.rollon.cn.com - info@rollon.cn.com

### ROLLON India Pvt. Ltd. - INDIA

1st floor, Regus Gem Business Centre, 26/1  
Hosur Road, Bommanahalli, Bangalore 560068  
Phone: (+91) 80 67027066  
www.rollonindia.in - info@rollonindia.in

### ROLLON - JAPAN

3F Shiodome Building, 1-2-20 Kaigan, Minato-ku,  
Tokyo 105-0022 Japan  
Phone +81 3 6721 8487  
www.rollon.jp - info@rollon.jp

Consult the other ranges of products



Distributor

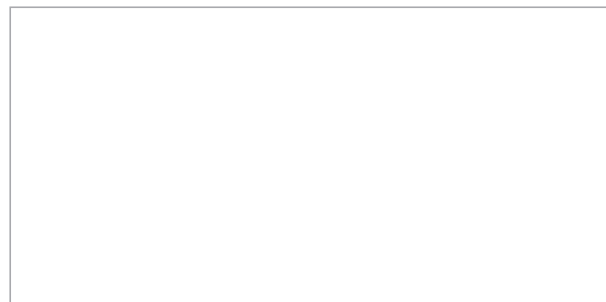

All addresses of our global sales partners can also be found at [www.rollon.com](http://www.rollon.com)

The content of this document and its use are subject to the general terms of sale of ROLLON available on the web site [www.rollon.com](http://www.rollon.com)  
Changes and errors expected. The text and images may be used only with our permission.