

6100



FEATURES:

- * Aluminum construction
- * Cross bar w/concealed vertical rod 84"
- * 36-48" available
- * AL/DU finish available

6300



FEATURES:

- * Aluminum construction
- * Cross bar type
- * 36-48" available
- * AL/DU finish available

7100



FEATURES:

- * Aluminum construction
- * Flat push type with concealed vertical rod 84"
- * 36-48" available
- * AL/DU finish available

7300



FEATURES:

- * Aluminum construction
- * Flat push type
- * 36-48" available
- * AL/DU finish available

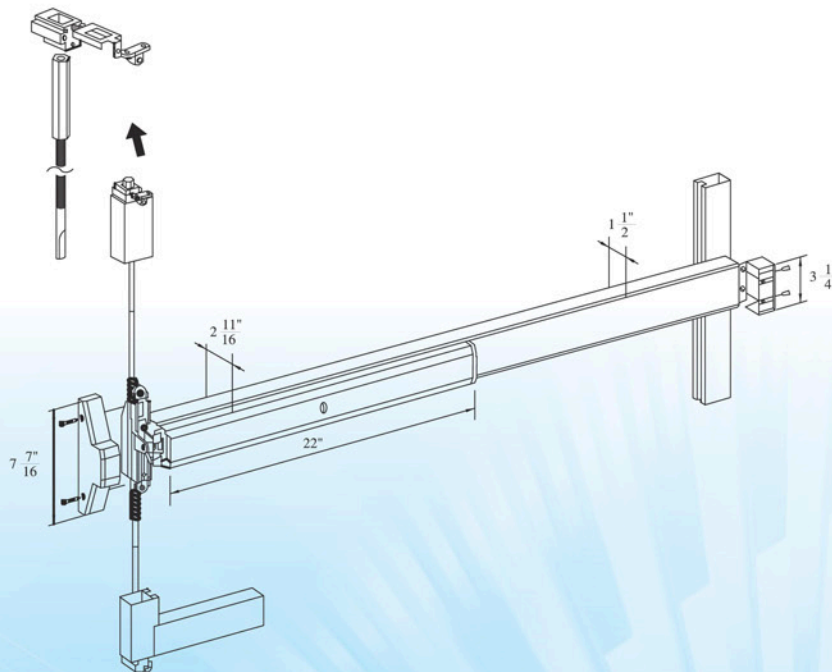

Panic Exit Device

500 Series

500S



- * Stainless Steel
- * Rim type

500



- * Painted Steel
- * Rim type

500VS



- * Stainless Steel
- * W / Vertical Rod

500V



- * Painted Steel
- * W / Vertical Rod

500.1SA



- * ANSI Grade 1, UL Listed, S.S., Rim Type

500.1A



- * ANSI Grade 1, UL Listed, Painted steel, Rim Type

500.1S



- * Stainless Steel



500.1



- * Painted Steel



500.1VS



- * Stainless Steel
- * W / Vertical Rod



500.1V



- * Painted Steel
- * W / Vertical Rod



UNITS : mm

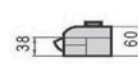
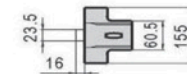
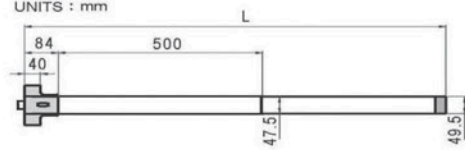

DEVICE
33" and 42"

5000 Series

5000S



- * Fire Rated
- * Stainless Steel
- * Rim type



5000



- * Fire Rated
- * Painted Steel
- * Rim type



5000 Series

5000VS



- * Fire Rated
- * Stainless Steel
- * W / Vertical rod



5000V



- * Fire Rated
- * Painted Steel
- * W / Vertical rod



5000SA



- * ANSI Grade 1 passed, 3 hours fire rated
- * Stainless steel, rim type



5000A



- * ANSI Grade 1 passed, 3 hours fire rated
- * Painted steel, rim type



Alarm Type

510S



- * Alarm Function
- * Stainless Steel
- * ANSI Grade 2

510P



- * Alarm Function
- * Painted Steel
- * ANSI Grade 2

Mortise Lock Exit Device

4200



- * ANSI Grade 1 standard A156.3
- * Material: Steel
- * For 36" to 48" door width
- * 33" or 42" available
- * Mortise Lock Grade 1 for 1-3/4"(44.5mm) thick doors, reversible.
- * w/ Standard ANSI strike
- * Handing



Coordinator

4100



- * Length of housing: 32", 42" 52", 60"
- * For door width: 34-43", 44-53", 54-96", 97-112"



Coordinator

4106/4108



- * ANSI 156.3 ; BHMA 4.4.4 TYPE ; UL listed
- * Material - Forged Brass, Nylon roller
- * #4106 - 7" projection
- * #4108 - 9" projection

Panic Exit Device

2000
2000S

2000 & 3000 series



- * ANSI Grade 1, UL listed
- * #2000 – Painted Steel
- * #2000S – Stainless Steel



3000
3000S



- * ANSI Grade 1, UL listed
- * 3 hours fire rated
- * #3000 – Painted Steel
- * #3000S – Stainless Steel



3000V
3000VS



- * ANSI Grade 1, UL listed
- * 3 hours fire rated
- * W/ vertical rod
- * #3000V – Painted Steel
- * #3000VS – Stainless Steel



2000V
2000VS



- * ANSI Grade 1, UL listed
- * W/ vertical rod
- * #2000V – Painted Steel
- * #2000VS – Stainless Steel



UNITS : mm

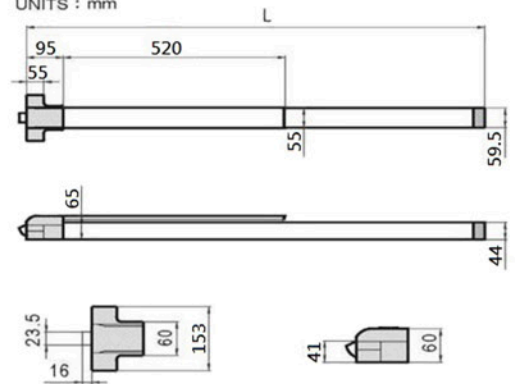

DEVICE

33" and 42"

2500
2500S

2500 & 3500 series



- * ANSI Grade 1, UL listed
- * #2500 – Painted Steel
- * #2500S – Stainless Steel



3500
3500S



- * ANSI Grade 1, UL listed
- * 3 hours fire rated
- * #3500 – Painted Steel
- * #3500S – Stainless Steel



3500V
3500VS



- * ANSI Grade 1, UL listed
- * 3 hours fire rated
- * W/ vertical rod
- * #3500V – Painted Steel
- * #3500VS – Stainless Steel



2500V
2500VS



- * ANSI Grade 1, UL listed
- * W/ vertical rod
- * #2500V – Painted Steel
- * #2500VS – Stainless Steel



UNITS : mm

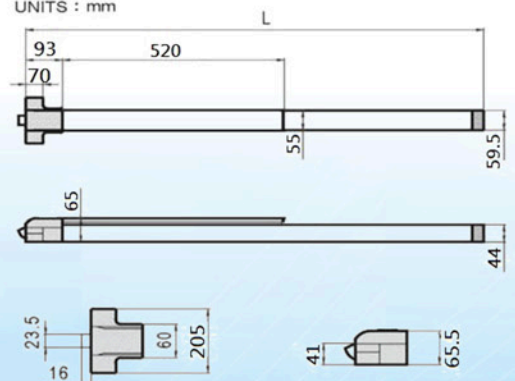

DEVICE

33" and 42"

Panic Exit Device

Trim Selection for Panic Exit Device

500.1.1

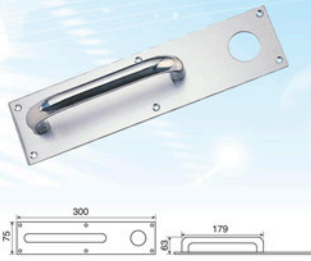

* Stainless Steel pull
* W / Cylinder Hole

500.1.2

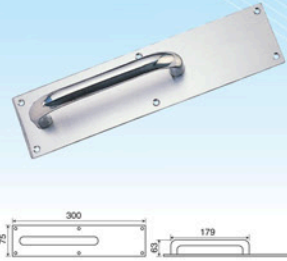

* Stainless Steel pull
* W / O Cylinder Hole

500.1.3

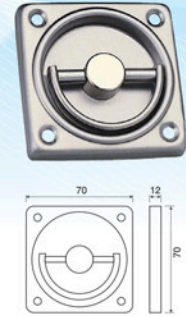

* Square Type pull
* Stainless Steel

500.1.4



* Round Type pull

500.1.5

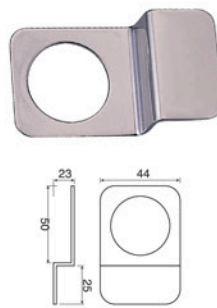

* N Type pull
* Stainless Steel

500.1.6

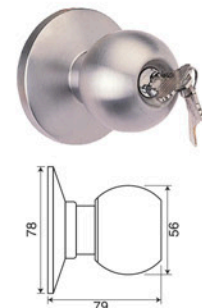

* Stainless Steel Knob handle

500.1.7

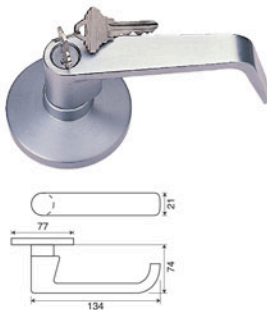

* Zinc Lever handle

500.1.8

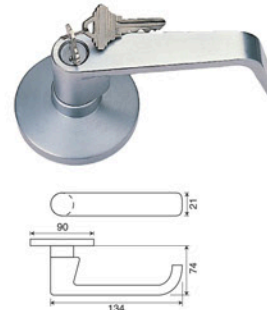

* Stainless Steel Lever handle

500.1.9

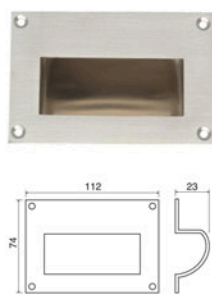

* Stainless Steel Pull

500.1.10



* Zinc Lever handle

500.1.11

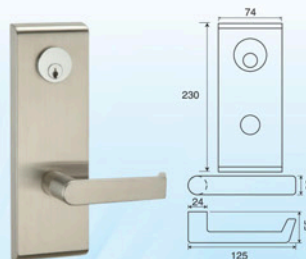

* Stainless Steel Lever handle

500.1.12

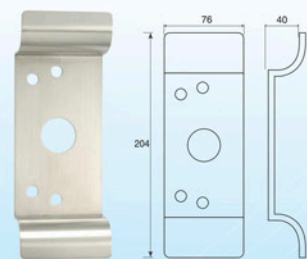

* Stainless Steel Pull

6307



FEATURES:

- * For 1-3/4" and 2-1/4" thick door
- * Steel housing, zinc lever
- * Rose 3-1/2" dia., lever 4-7/8" length
- * Entrance, storeroom, passage, dummy models available

6308



FEATURES:

- * For 1-3/4" and 2-1/4" thick door
- * 2-5/16" x 8-12" faceplate
- * Entrance, storeroom, passage, dummy models available

6321



FEATURES:

- * Size: 283 x 118mm, C.C: 255mm
- * Anodized silver and anodized bronze finishes available
- * Aluminum material

6322



FEATURES:

- * Compatible with panic exit device #6100 & #7100
- * Accept 1-5/32" mortise keyed cylinder
- * Aluminum material
- * With 2 brass keys
- * AL / DU finish available

6303



FEATURES:

- * 5 pins mechanism
- * Brass material
- * Size: 31.5mm dia. x 1-1/4"
- * For panic exit device #6300 / 7300

6103



FEATURES:

- * Compatible with panic exit device #6100 / 7100
- * 1" x 1-5/32" dia.
- * 5 pin tumbler cylinder
- * With 2 brass keys
- * AL / DU finish available

6104

Mounting Ring



FEATURES:

- * Parts of screw-in cylinder #6103 for panic exit device #6100 / 7100
- * AL / DU finish available

6106

Rod Extension



FEATURES:

- * Compatible with vertical rod of panic exit device # 6100 / 7100
- * 3/8" - 16 UNC thread
- * 12" & 24" available
- * Provided with coupler

