



Universal Mixer Revolution™

Gentle mixing revolutionized

TOOLLESS MIXING SYSTEM | GENTLE ON MATERIALS | NO HEAT INPUT

Gefördert durch:



Bundesministerium
für Wirtschaft
und Technologie

aufgrund eines Beschlusses
des Deutschen Bundestages

Gentle mixing without tools

Large cooling surface with low energy consumption

MIXACO Revolution™ is a mixing system that functions without active moving mixing tools. Gentle mixing of materials during rotation of the container is achieved with built-in mixing segments. This technology without driven mixing tools prevents additional thermal heatup for the product.

The MIXACO Revolution™ can also be supplied as an optional double-walled version with optimized flow characteristics for temperature-controlled mixing. A central inlet device enables the controlled dosing of liquids during the mixing process, if required for specific applications.

A motorized pivot mechanism moves the mixer automatically to the charging and discharging position. The lateral sealing covers of the mixer can be opened to enable the significant reduction of cleaning times.

THE MIXING PROCESS

Homogenization for large batches

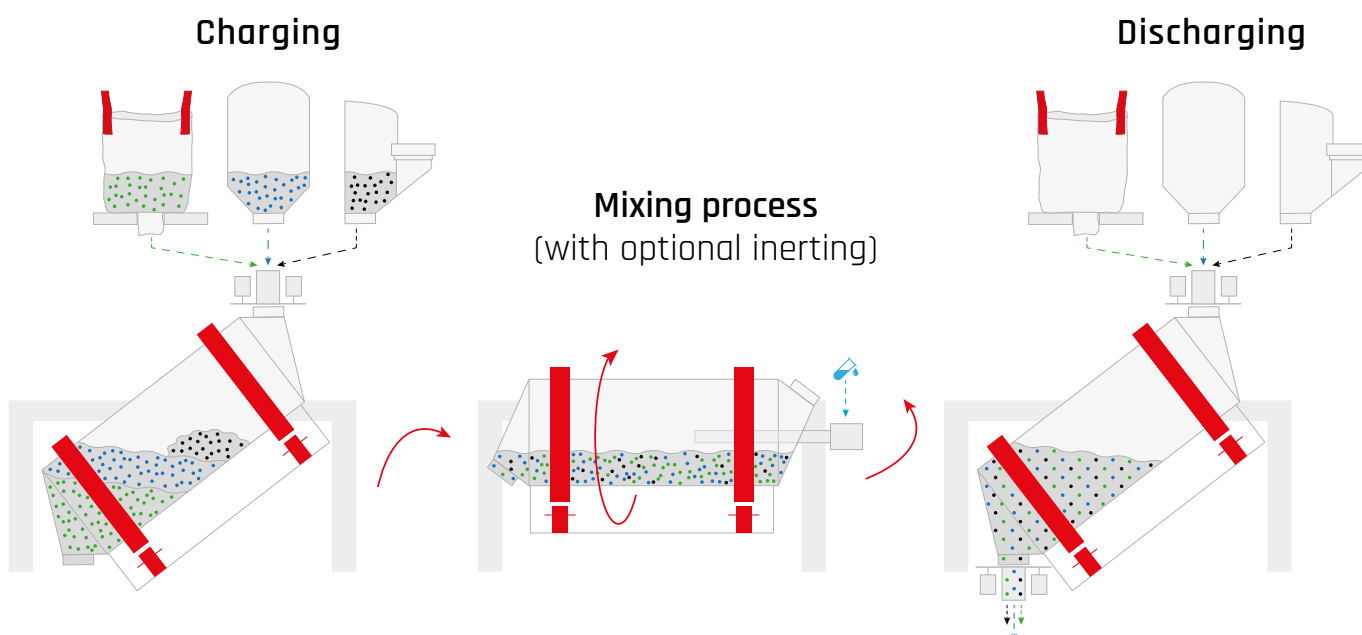

The largest mixer that MIXACO has ever built:
10,000 liters



Control

Our mixing equipment is controlled with a Siemens S7 PLC and meets today's requirements for safety, efficiency and cost-effectiveness. Since the control is developed and programmed by one and the same company, it is virtually ensured that the mixer components are optimally integrated. Alternatively, you can also use Allen Bradley components (incl. the Panelview operating panel). Control can also be designed according to UL / NEMA. Additionally, the control can be equipped with an interface for data exchange with higher-level control.



Siemens TP700

- Using the touch control panel TP700, up to 99 mixing programs can be created in table form with ten work steps each.
- Data recording and storing measured values



Allen Bradley

- Control according to UL / NEMA standards with an Allen Bradley PLC and a Panelview operating panel

Remote maintenance module

The remote maintenance module enables fast and secure access to the combined mixer controller via a VPN tunnel. This in turn allows our service team to diagnose and rectify any malfunctions without having to visit the site.

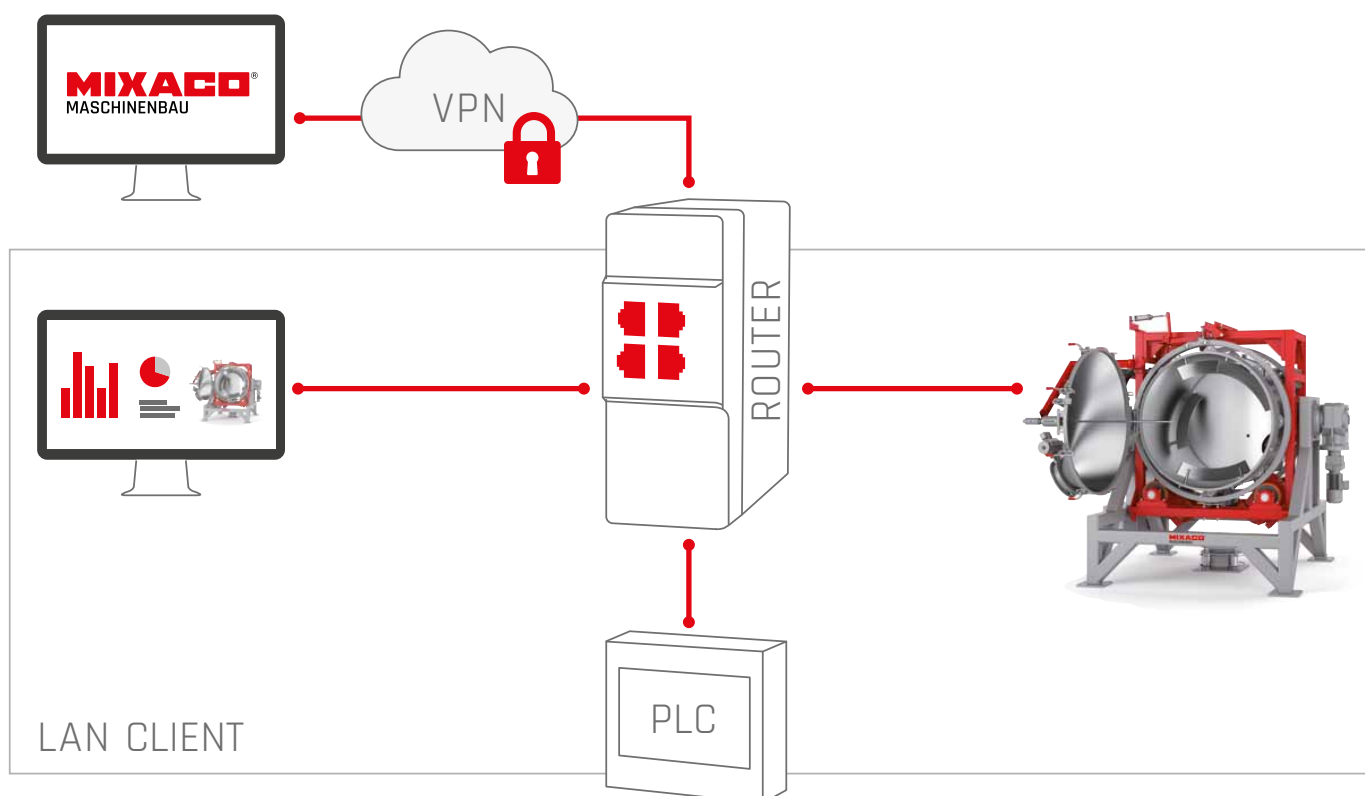

Details

Rotating unit

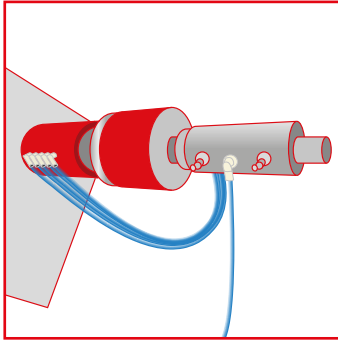

Mixing rollers

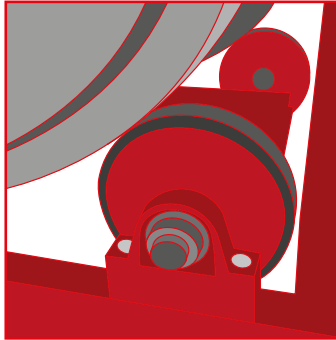

Tools

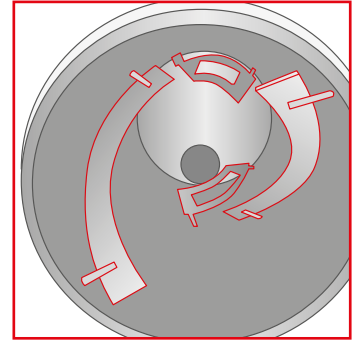

Lid with temperature sensors

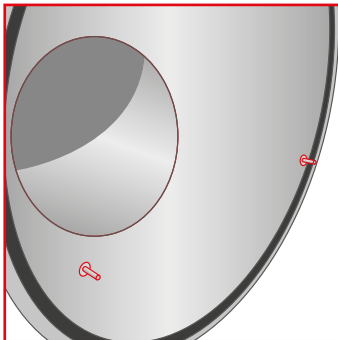

Charging coupling

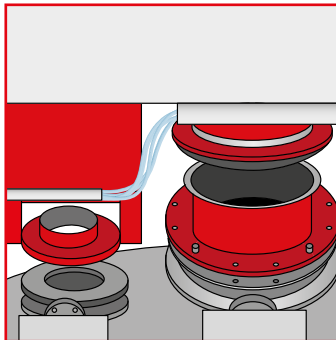

Inerting

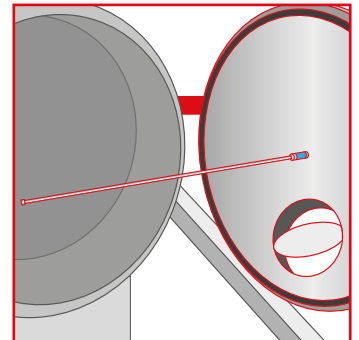

ATEX



Depending on the version, our mixers can be used in potentially explosive dust and gas atmospheres of all ATEX zones. The machine acceptance is carried out and documented by an official inspecting authority or a correspondingly certified employee.

Up to EX zone 20 without inerting!

ATEX classification

Equipment for use in potentially explosive dust atmospheres

Zone	20	21	22
Hazard	continuously, for long periods or frequently	occasionally	seldom or for a short period of time

Technical Data

Best mixing quality for a wide variety of applications

XLDPE | POWDER COATINGS | MASTERBATCHES | PVC | AND MANY MORE

Various applications

For particularly gentle mixing processes:

- Gentle homogenization
- Homogenization of several material batches
- Dyeing
- Coating
- Wetting
- Material-friendly temperature control with double-walled vessel
- Mixing of sensitive materials

Maximum functionality

Additional expansion options:

- Docking station for dust-free charging and discharging
- Temperature measurement point
- Injection of liquids and gases during mixing
- Temperature control with water-bearing double-wall vessel
- ATEX version
- Data recording and evaluation
- Remote maintenance

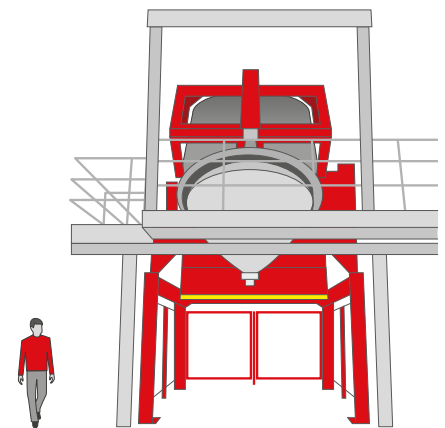

Size	Batch size kg/batch	Motor Power kW
Revolution™		
500	85	2 x 3
1000	140	2 x 3
1000	185	2 x 3
1500	230	2 x 5,5
1500	270	2 x 5,5
2500	350	2 x 5,5
2500	410	2 x 5,5
3500	500	2 x 5,5
3500	620	2 x 5,5
4500	800	2 x 7,5

Experience in Many Industries

MIXACO has been offering solutions for a wide variety of industries for many decades. This means the requirements on the mixing technology are correspondingly varied. MIXACO has profound expertise across many industries and can precisely and positively adapt the wide product assortment to each individual mixing task.

Particularly when it comes to combined revolution mixers, customers can benefit from comprehensive advice and customer-specific solutions. Whether new projects or the optimization of existing plants, MIXACO will be by your side throughout a successful installation and commissioning.

No other company stands for innovation in mixing technology like MIXACO, who has been setting new standards with its machinery and solutions for decades. Leading companies of numerous industries worldwide trust in MIXACO products, including:



Cable Insulation



PVC Pipes



WPC Profiles



Powder Coatings / Bonding



Masterbatches

Save the Best for Last

All advantages at a glance:

- Gentle homogenization of large quantities
- No inadvertent warming of mixing materials
- No abrasion of granulates
- Double-walled mixing vessel allows temperature-controlled mixing
- Energy-efficient through low drive power consumption
- 100 % discharge by pivoting to discharging position
- Good accessibility for fast, easy cleaning
- Tool-free design makes maintenance easy
- Suitable for ATEX applications (up to zone 20 without inertization of protective gases)

Good ideas are conceived.
But the right solutions are put to the test.



Contact us for your mixing trials and benefit from the extensive experience of our design and application engineers:

- Tests on various mixing systems
- Adaptation of mixing parameters
- Recording and documentation of mixing tests
- Analysis of mixing results



MIXACO

Dr. Herfeld GmbH & Co. KG

Niederheide 2
58809 Neuenrade
Deutschland

Phone +49 2392 9644-0
Fax +49 2392 62013
info@mixaco.de

MIXACO USA LLC

1784 Poplar Drive
Greer, SC 29651
USA

Phone +1 864 331 23 20
Fax +1 864 331 23 21
info@mixaco.com

Gefördert durch:



Bundesministerium
für Wirtschaft
und Technologie

aufgrund eines Beschlusses
des Deutschen Bundestages