

DIGITAL CONTROLLER | TX LVDT

Highly accurate measurement results without linearity errors.

- Improves transducer linearity to 0,01%
- High resolution (16 bit)
- High dynamics
- Digital output: CAN, USB-Interface
- Analog output
- High noise immunity

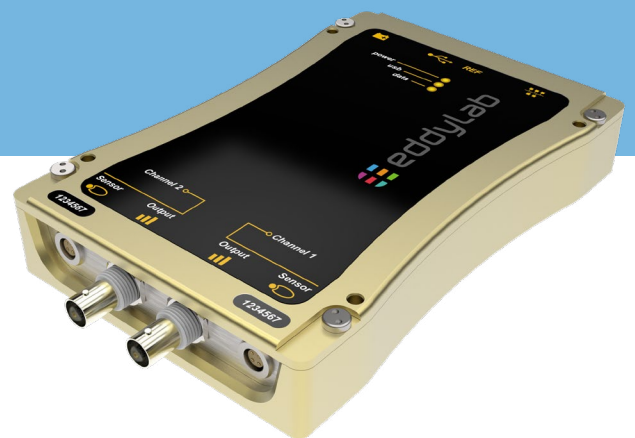

LVDTs (Linear Variable Differential Transformers) are inductive sensors excellent for use in harsh industrial environments, e.g. high temperature and pressure ranges, as well as high accelerations and measuring cycles.

The linearity optimization represents the main issue to LVDT transducers. The linearity is typically at a value of 0.3 %, values of less than 0.1 % are hardly to realize. The LVDT digital controller from eddylab, to which either one or two sensors can be connected, now considerably improves the linearity of inductive displacement transducers.

THE BASIC PRINCIPLE

The measurement chain, consisting of LVDT, cable and electronics, is adjusted and calibrated at the eddylab calibration laboratory. At the beginning eddylab adjusts the TX LVDT controller to the connected transducer to maximize the sensitivity of the sensor. After a first calibration, the controller conditions, digitizes and linearizes the transducer signal and outputs it as an analog voltage or current signal as well as via CAN bus or USB. The customer receives a traceable calibration certificate as a confirmation of the superior performance.

KEY POINTS

- Admits linearities less than 0,01 %
- Higher resolution compared to analog electronics (0,00175 % of full scale)
- High sampling rate to capture fast events
- CAN-signal, robust, cost-effective
- Free software „eddylab“

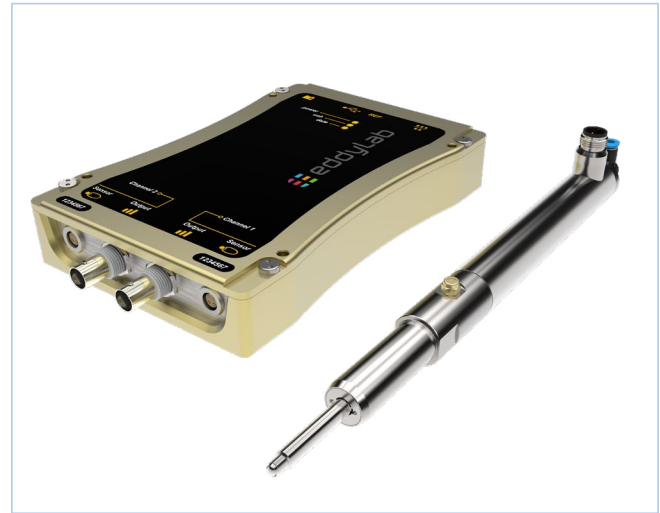

TX LVDT DIGITAL CONTROLLER

The processor based design admits linearities less than 0,01 % - which is an exceptional feature for this sensor technology. Remarkable performance allows highly dynamic measurements with 124 kSa/s.

The TX LVDT digital controller is available as single- or dual-channel device. As standard, the device provides a USB and a CAN-bus Interface. The power supply is a galvanically isolated wide input from 10.5...36 (27) VDC.

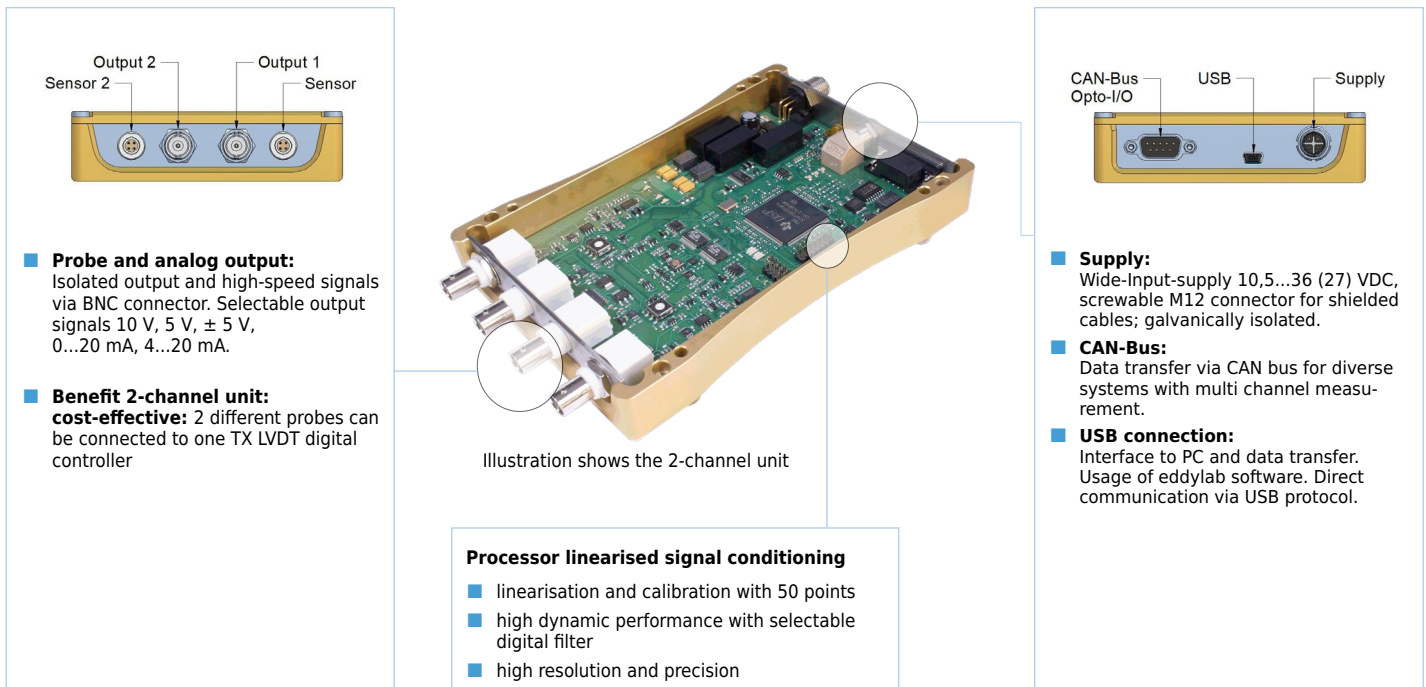

TECHNICAL DATA



TX LVDT DIGITAL CONTROLLER	TX1 LVDT	TX2 LVDT
channels	1 channel	2 channel
operating temperature range	-40...+50 °C	
storage temperature range	-50...+85°C	
humidity	95 % (no condensation)	
vibration	5 g, DIN EN 60068-2-6	
shock	15 g / 11 ms, DIN EN 60068-2-27	
protection class	IP40	
housing	anodised aluminium with rubber feet, stackable, optional DIN rail mount	
housing size	195 x 116 x 29,5 mm (l x w x h)	
weight	665 g	694 g
Supply		
supply voltage	10,5...36 VDC Wide Input	
current consumption	150 mA (24 V), 240 mA (12 V), 270 mA (10.5 V)	150 mA (24 V), 300 mA (12 V), 330 mA (10.5 V)
power on peek current	350 mA (24V), 470 mA (10,5V), < 30 ms	
reverse polarity protection	yes	
protection circuit	bipolar suppressor diode 36V / polyfuse 0.5A	
isolation voltage	mind. 1 kV	
Analog output		
output signal	4...20 mA	
resolution	0.00175 % of full scale	
filter corner frequency	10 Hz / 100 Hz / 1 kHz (-3 dB)	
max. working resistance (current output)	< 400 Ohm	
temperature coefficient electronic	-0.025 %/K	
switching-on delay (boot-time)	3,1 s	
switching-on drift	< 1% (see diagram)	
connection output	1 x BNC female connector	2 x BNC female connector
output protection circuit	polyfuse 50mA	
General data and industrial standards		
electromagnetic compatibility	EN 61326-1 / EN 55011	
RoHS	appropriate standard 2002/95/EG	
MTBF	EN 61709, > 360.000 h	
customs declaration number	90318034 country of origin Germany	

TECHNICAL DRAWING

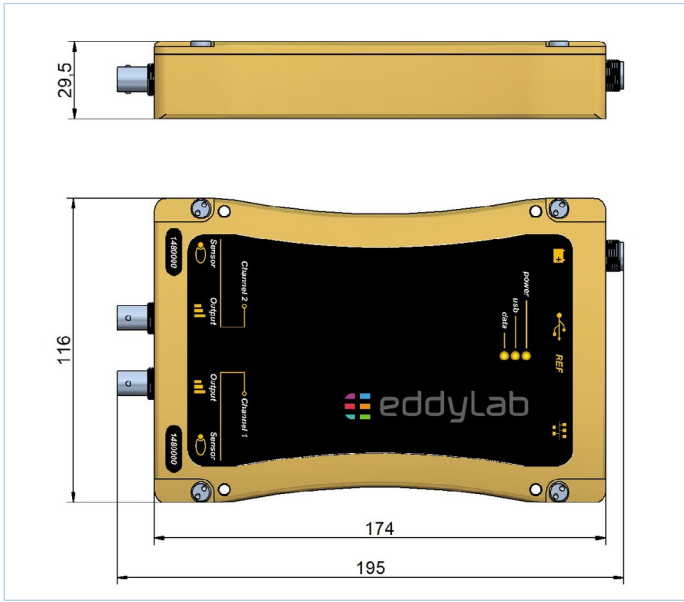

CONNECTION

FRONT OF UNIT

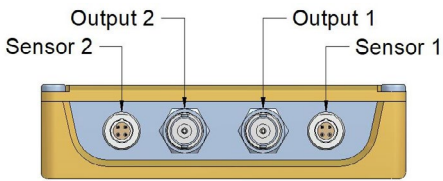

REAR OF UNIT

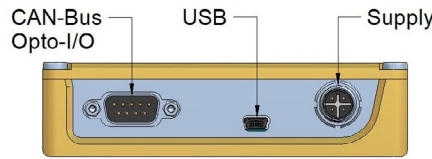

USB

- The TX LVDT digital controller provides a USB port (USB 2.0 High Speed).
- device configuration (filter, linearisation, CAN bus)
- data exchange with a PC or notebook via eddylab Windows software or via protocol

ASSIGNMENT SENSOR

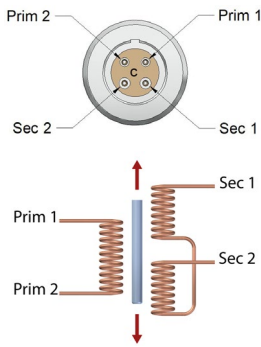

SUPPLY VIA A 4-POLE M12 PLUG CONNECTOR (SOCKET)

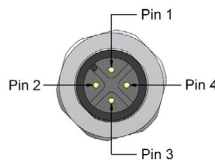

PIN	FUNCTION
1 (brown)	+V (10,5...36 VDC)
3 (blue)	GND

PLEASE USE ONLY SHIELDED SUPPLY CABLES AND SET THE SCREEN ON ONE SIDE (TO AVOID GROUND LOOPS)!

SAMPLING RATES	TX1	TX2
Analog, no USB	124 kSa/s	70 kSa/s
Analog, with USB	76 kSa/s	45 kSa/s
USB	38 kSa/s	22,5 kSa/s



CAN-BUS

The electronics also provide a CAN-bus interface (controller area network). Wiring is achieved with a CAN-bus cable. The first and the last device on a CAN bus must be terminated.

- data transfer rate 1 MBit, standard-identifier
- triggers: internal timer, remote request, sync.
- networking of many devices with minimal wiring effort
- highly reliable data transfer over wide ranges, ideal for applications with many devices (consider dynamics)
- economisation of analog measuring equipment (analog-to-digital converter)

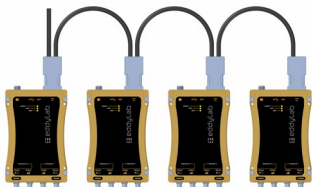

PIN	FUNCTION	DESCRIPTION
1	EXT OPTO OUT 1	digital output I/O 1
2	CAN L	CAN low-signal
3	CAN GND	CAN ground
4	EXT IN 1	digital input I/O 1
5	EXT IN 2	digital input I/O 2
6	IN GND	ground I/O
7	CAN H	CAN high-signal
8	EXT OUT 2	digital output I/O 2
9	n. c.	n. c.

ACCESSORIES

EDDYMOTION LVDT

Powerful Windows software incorporating two major functions:

- Oscilloscope, Data logger
- [free-download](#).

eddylab
sensor software
eddyMOTION^{LVDT}

DIN RAIL CONNECTOR

- The DIN rail connector provides an easy and secure mounting of the TX LVDT digital controller in a switch cabinet by simply snapping it onto a 35 mm DIN rail (DIN50022).
- Disassembling can be done by pulling the easy accessible latch.
- Stacking of several electronics can save lots of space in the switch cabinet. Therefore, please use the included housing connectors.

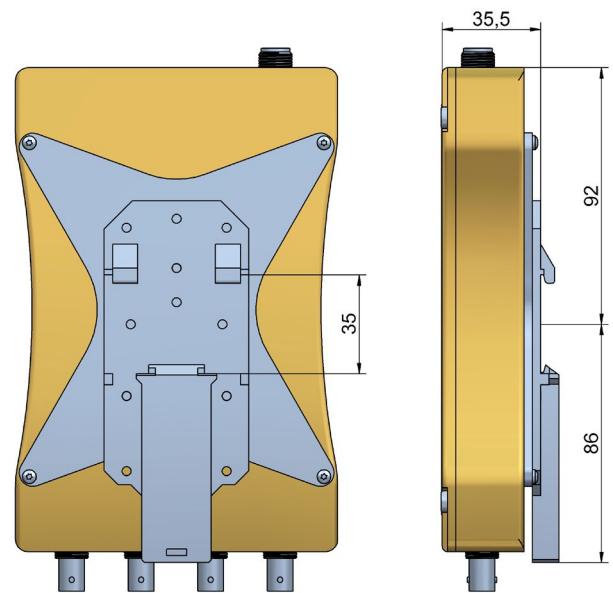

M12 CABLE FOR POWER SUPPLY

Cable with straight connector:

K4P2M-S-M12	2 m
K4P5M-S-M12	5 m
K4P10M-S-M12	10 m

Cable with angled connector:

K4P2M-SW-M12	2 m
K4P5M-SW-M12	5 m
K4P10M-SW-M12	10 m



BNC MEASUREMENT CABLE FOR ANALOG OUTPUT

XLSS-58

- Touch-safe coaxial measurement cable. BNC connectors on both ends. Connectors have nickel plated shields and gold plated pins.
- Length 2 m, temperature range -10...+70 °C
- Capacity 219 pF, inductance 680 nH, wave impedance 50 Ω



XLAM-446/SC

- Highly flexible, entirely shielded measurement cable. Touch-safe BNC connector on one end and two stackable Ø 4 mm connectors on the other end
- Length 1.6 m, temperature range -10...+70 °C
- Capacity 240 pF, inductance 1000 nH



ACCESSORIES

■ WALL PLUG TRANSFORMER

■ nominal input voltage:	100-240 VAC, 50-60 Hz
■ output voltage:	12 VDC \pm 5 %
■ output current:	500 mA
■ temperatur range:	0...+40 °C
■ protection class	IP40
■ cable length	2 m
■ terminal	M12-plug, PIN 1 = +, PIN3 = GND



■ RAIL-POWER SUPPLY 24 VDC PS-100-240AC/24DC/1.3

Extra slim power supply - only 22.5 mm wide. Reliable start-up of several TX LVDT digital controllers is guaranteed by a 100% power boost. Reliability is also achieved on difficult global networks. The supply will remain stable even if transient or static voltage failure occurs. Well dimensioned capacitors bypass power failures of more than 150 ms.

■ nominal input voltage:	100-240 VAC, 45-65 Hz
■ output voltage:	24 VDC
■ output current:	1,3 A (max. 1,6 A)
■ temperature range:	-25...+60 °C
■ efficiency:	> 85 %
■ protection class:	IP20

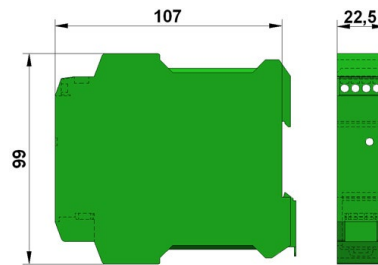

SOFTWARE EDDYMOTION LVDT – OPTIONAL USE

EDDYMOTION – WINDOWS ANALYSIS-SOFTWARE VIA USB

eddyMOTION LVDT is a powerful windows software which is available for the TX LVDT controller featuring **Oscilloscope** and **Data logger function**. eddyMOTION LVDT is available as a **free-download**. The sampling rates are 38 kSa/s for a single-channel device and 22.5 kSa/s for a dual-channel device. Furthermore eddyMOTION LVDT is used to configure the TX LVDT Digital Controller.

OSCILLOSCOPE

Sampled data is displayed with basic measurements in the style of a classical oscilloscope.

- single- and dual-channel oscilloscope. Samplingrates: 38 kSa/s (single); 22.5 kSa/s (dual)
- AC/DC-coupling
- variable time base 14 ms...5 sec
- scaleable Y-axis & autoscale function
- user-defined trigger level, hysteresis and pre-trigger, trigger source, falling and rising edge
- essential measurements on dynamic data can be taken: amplitude, frequency, max & min values
- data export as image (bmp) and text file

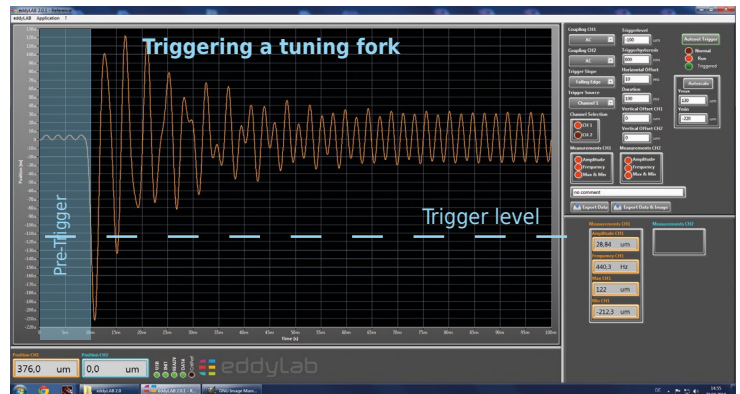

DATA LOGGER

Record of measured data and storage on hard drive.

- user-defined sampling rate: 100 ms...10 s
- time base 1 min...60 min
- data export as image (bmp) and text file

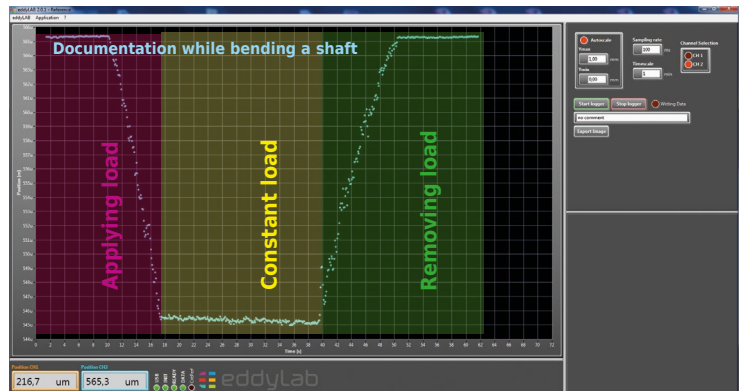

FUNCTION OVERVIEW	EDDYMOTION LVDT
Oscilloscope	X
Data logger	X

ORDER CODE

TX-LVDT



a TX basic module type

TX1 = 1-channel
TX2 = 2-channel

b analogue output

020A = 0...20 mA
420A = 4...20 mA
10V = 0...10 V
5V = 0...5 V
±5V = ±5 V

