

## 薄膜专用接线盒 BIPV Junction Box

### 产品规格

#### Product Specifications

接线盒本体材料 BOX Material	PPE	阻燃等级 Flame Class	UL94-V0
额定电流 Rated current	A:14A(20A diode) B:18A(25A diode)	环境温度范围 Ambient temperature range	-40℃...+85℃(IEC)
额定电压 Rated voltage	1500VDC	适配电线规格 Suitable cable cross sections	4.0mm <sup>2</sup>
测试电压 Test voltage	8kV(50Hz,1min)	二极管数量 Diode Number	Each 1PC
连接器接触电阻 Typical contact resistance	≤5mΩ	温度上限 Upper limiting temperature	110℃(IEC)
金属导体材料 Contact material	铜,镀锡	电缆外径 Range of cable gland(mm)	O.D.:5.5
保护等级 Degree of protection	IP68(In potting)	汇流条尺寸 Ribbons size(mm)	6(W)*0.2-0.4(T)
安全等级 Safety degree	II	汇流条连接 Connection of bus ribbons	Clamp/Soldering

### 图示

#### Drawing

#### Mid Box JBBM01-\*\*

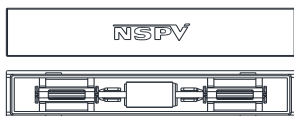

#### Negative Box JBBN01-\*\*

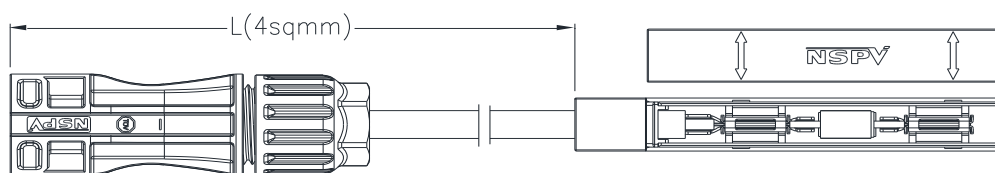

#### Positive Box JBBP01-\*\*

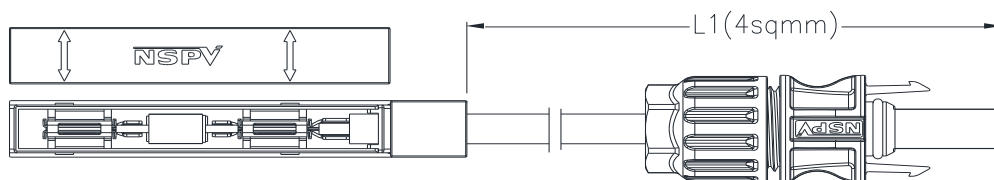

#### Twin Box JBBT01-\*\*

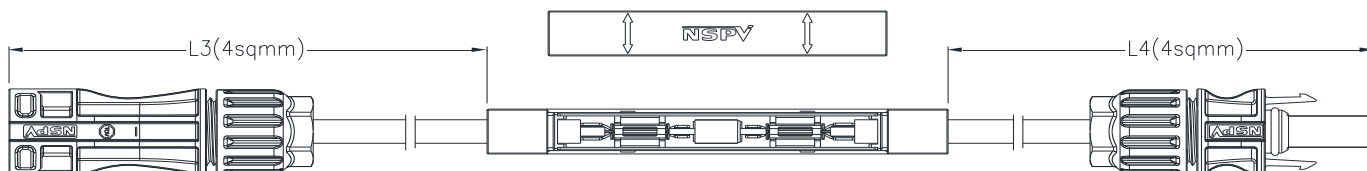

# 薄膜专用接线盒 BIPV Junction Box

## 产品应用

### Production Application

1:0:1(Negative : Middle : Positive)



1:1:1(Negative : Middle : Positive)

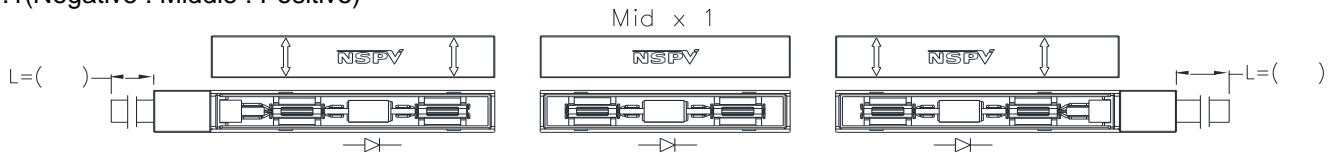

1:2:1(Negative : Middle : Positive)

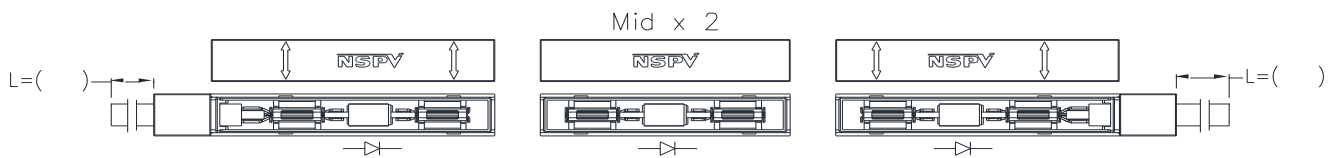

1:3:1(Negative : Middle : Positive)

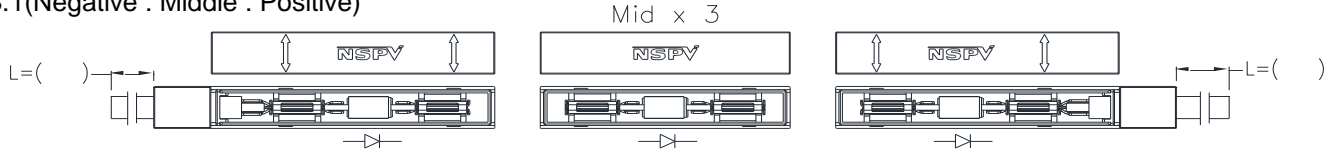

1:4:1(Negative : Middle : Positive)

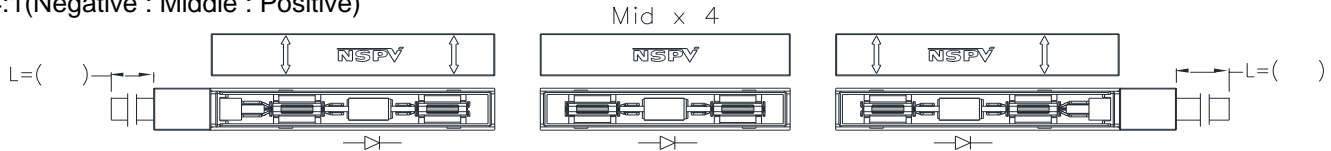

1:5:1(Negative : Middle : Positive)

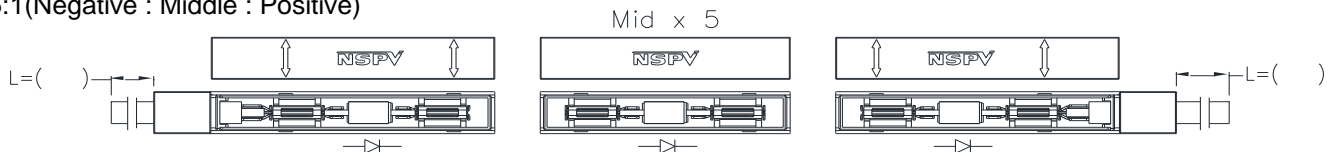

## 安装参考位置

### Installation reference location

Side of module

Back of module

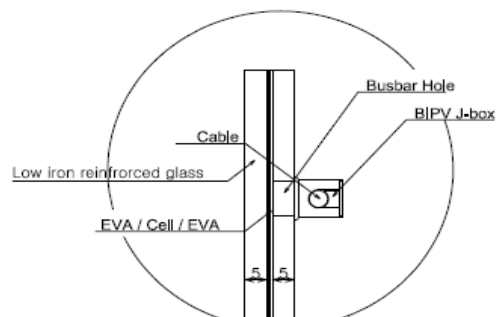
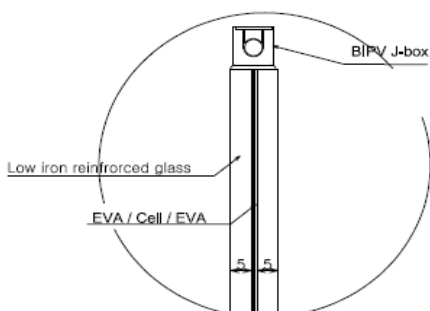

**Remark:** Ensure that the junction box and photovoltaic panel are firmly bonded.

# 薄膜专用接线盒 BIPV Junction Box

## 连接器的搭配 Connector Selection

Newsun 1000VDC cable connector:

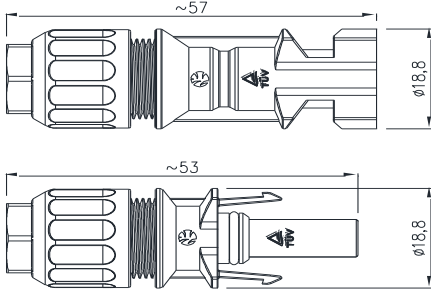

Newsun 1500VDC cable connector:

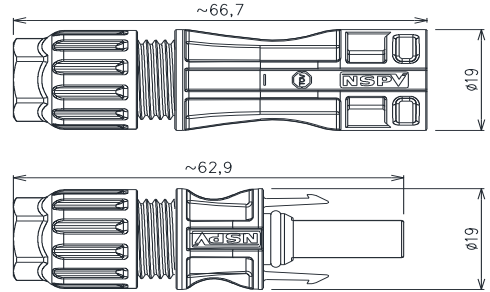

Newsun 1000VDC PV3.0 cable connector:

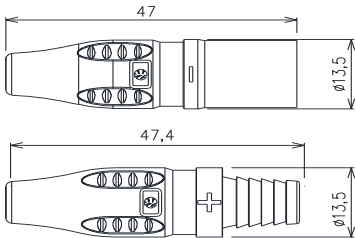

Newsun 1000VDC Mini cable connector:

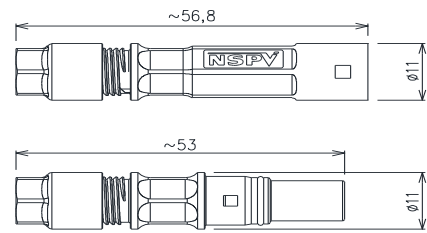

MC4 cable connector

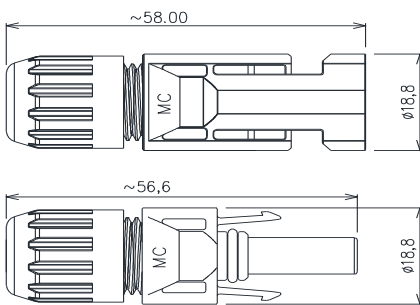

MC4\_EVO cable connector

